

2024

Food Equipment



Chi siamo

Our Story

Siamo i professionisti per i professionisti

La collezione Pavoni Italia è caratterizzata da idee innovative e prodotti dal design unico, realizzati in collaborazione coi migliori professionisti del settore. Una ricerca lunga oltre 40 anni verso la perfezione, con strumenti pensati, disegnati e prodotti per trasformare la pasticceria in design, ogni preparazione in una piccola opera d'arte. Qualità dei materiali, un reparto dedicato alla ricerca e sviluppo, continua innovazione nella forma e nelle soluzioni. Tutto ciò ispira costantemente la nostra produzione, prima di arrivare nelle mani dei professionisti di tutto il mondo. Ecco i prodotti Pavoni. La migliore strumentazione per cioccolato, dessert da cottura e surgelazione, gelateria, insieme a colori e materie prime dedicati al settore alimentare.

Oltre 6.000 prodotti destinati ai professionisti della pasticceria, gelateria e della ristorazione. Nata nel 1980 come produttrice di contenitori in plastica per il mondo della panificazione, oggi Pavoni Italia è azienda di riferimento nel Mondo. Un marchio italiano con una storia riconosciuta di attenzione alle esigenze dei professionisti, che conosce da vicino la differenza tra semplici strumenti di lavoro e oggetti votati all'eccellenza, capaci di ispirare la creatività di Chef e Pastry Chef. Per fare questo, ci ispiriamo ai nostri valori. Una reale dedizione al cliente, fatta di ascolto e attenzione. Scelte orientate da coerenza e chiarezza, coadiuvate da una grande capacità produttiva. Un cuore grande, perché amiamo ciò che facciamo. E la consapevolezza di essere scelti dai migliori.

We are the professionals for the professionals

Pavoni Italia collection is characterised by innovative ideas and unique design products, realised in collaboration with the best professionals of the sector. More than 40 years long research towards perfection, with tools conceived, designed and produced to turn pastry into design, every preparation into a little work of art. Quality materials, a department dedicated to research and development, continuous innovation in form and solutions. All this constantly inspires our production, before reaching the hands of professionals all over the world. Here are the Pavoni products. The best equipment for chocolate, baking and freezing desserts, ice-cream, together with colours and raw materials dedicated to the food industry.

More than 6.000 products destined to the professionals of pastry, ice-cream and catering. Founded in 1980 as a manufacturer of plastic containers for the bakery world, today Pavoni Italia is a reference company in the World. An Italian brand with a recognized history of attention to the needs of professionals, which knows closely the difference between simple working tools and objects devoted to excellence, able to inspire the creativity of Chefs and Pastry Chefs. To do this, we are inspired by our values. A real dedication to the customer, made up of listening and attention. Choices guided by consistency and clarity, aided by a great production capacity. A big heart, because we love what we do.

Indice

Index

- 5** **Novità**
New products
- 39** **Pasticceria**
Pastry world
- Stampi in silicone /
Silicone moulds
- 41 Stampi per monoporzioni /
Single-serving portions
moulds
- 77 Stampi per medieporzioni /
Medium portions moulds
- 83 Stampi per miniporzioni /
Mini-portions moulds
- 91 Stampi per sfere /
Sphere moulds
- 97 Formaflex
- 107 Stampi per torte /
Cakes moulds
- 133 Stampi per tronchetti /
Logs moulds
- 145 Stampi per top /
Top moulds
- 157 Tappetini per decorazioni /
Decoration mats
- 163 Gourmand Inspiration
- 169 Formasil
- Fasce inox /
Stainless steel bands
- 177 Fasce inox microforate /
Micro-perforated stainless
steel bands
- 191 Fasce inox lisce /
Smooth stainless steel
bands
- 199** **Gelato**
- Attrezzature e stampi per gelato /
Gelato equipments and moulds
- 201 Stampi per stecchi gelato /
Moulds for gelato sticks
- 209 Stampi per vaschette
gelato /
Moulds for gelato pans
- 213** **Ristorazione**
Horeca
- 215 Stampi in silicone
tridimensionali /
Three-dimensional silicone
moulds
- 235 Tappetini in silicone
per decorazioni /
Silicone mats for decorations

**245 Cioccolateria
Chocolate world**

- 247 Stampi per praline /
Praline moulds
- 261 Stampi per tavolette /
Choco bar moulds
- 273 Stampi tridimensionali
per cioccolato /
Three-dimensional
chocolate moulds
- 311 Stampi termoformati serigrafati /
Silkscreened thermoformed
moulds
- 321 Serigrafie /
Silkscreens
- 329 Transfer e blister personalizzati /
Custom transfer and blister
- 339 Attrezzature per cioccolato /
Chocolate equipment

**345 Colori e
materie prime
Colours and
raw materials**

**369 Attrezzature
Equipment**

- 371 Stampi monouso /
Disposable moulds
- 375 Tappetini in silicone /
Silicone mats
- 381 Storage and display
- 389 Tools

**429 Contenitori
Crates**

- 431 Contenitori in plastica /
Plastic crates
- 441 Termobox

451 Ambassadors

**479 Festività
Celebration**

- 483 Silicone
- 484 Indice alfabetico /
Alphabetical index

Novità
New Products



**Croissant geometrici /
Geometric croissants**

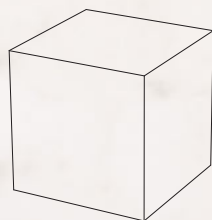

CV1 Cubo
Stampo in acciaio inox /
Stainless steel mould

mm 60×60×60 h



CV2 Cilindro
Stampo in acciaio inox /
Stainless steel mould

mm Ø 65×60 h

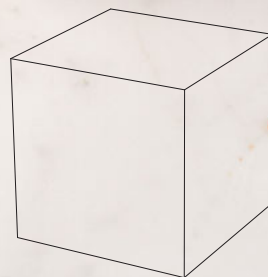

CV3 Cubo
Stampo in acciaio inox /
Stainless steel mould

mm 70×70×70 h



Credits: Le Photographe du Dimanche

Pavoflex 400×300 mm

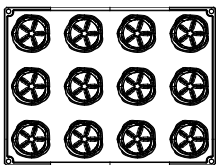

PX43103
Easter mono
by Jérôme de Oliveira

Ø mm 70×72 h
~ 120 ml
12 impronte / indents



Credits: Le Photographe du Dimanche

Pavocake

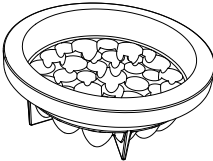

KE094
Easter cake
by Jérôme de Oliveira

Ø mm 160×65 h
~ 940 ml

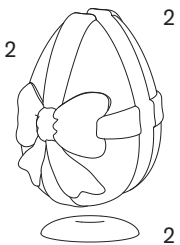

Stampi termoformati /
Thermoformed moulds

KT216
Cadeau

Ø mm 145×215 h
~ 340 g

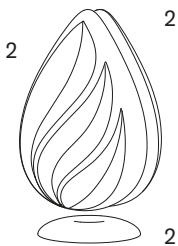

Stampi termoformati /
Thermoformed moulds

KT217
Flame

Ø mm 130×215 h
~ 340g

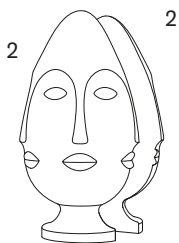

Stampi termoformati /
Thermoformed moulds

KT218
Modi

Ø mm 135×235 h
~ 340 g





Stampi per praline 275×175 mm / Praline moulds 275×175 mm
Adatti alle macchine One Shot / Suitable for One Shot machines

PC5061
Cubo
by Ramon Morató

mm 30×30×30 h
~ 25 ml
24 impronte / indents

PC5062
Cubo
by Ramon Morató

mm 20×20×20 h
~ 9 ml
32 impronte / indents

PC5063
Cubo
by Ramon Morató

mm 17×17×17 h
~ 5 ml
45 impronte / indents



Pavoflex 400×300 mm

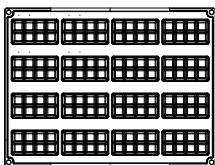

PX43106
Tablette
by Cédric Grolet

mm 85×45×30 h
~ 100 ml
16 impronte / indents





Pavocake

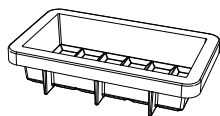

KE095
Tablette
by Cédric Grolet

mm 185×95×45 h
~ 750 ml



Pavoflex 400×300 mm

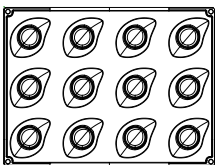

PX43104
Mango
by Cédric Grolet

mm 90×58×35 h
~ 95 ml
12 impronte / indents



Pavoflex 400×300 mm

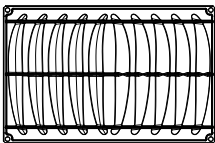

PX43105
Vanilla
by Cédric Grolet

mm 225×32×35 h
~ 80 ml
10 impronte / indents



Top

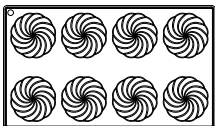

TOP28
Twirl
by Emmanuele Forcone

Ø mm 60×8 h
~ 18 ml
8 impronte / indents



Top

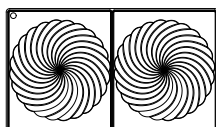

TOP29
Twirl
by Emmanuele Forcone

Ø mm 140×10 h
~ 120 ml
2 impronte / indents

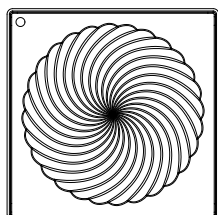

Top

TOP30
Twirl
by Emmanuele Forcone

Ø mm 160×10 h
~ 160 ml
1 impronta / indent



Pavoflex 400×300 mm
Mini-portions

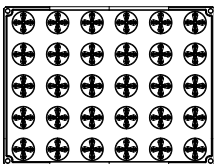

PX4398
Jasmine
by Antonio Bachour

Ø mm 38×30 h
~ 20 ml
30 impronte / indents



Pavoflex 400×300 mm
Mini-portions

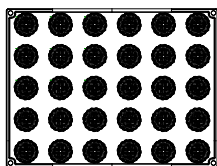

PX4399
Façon Saint-Honoré
by Cédric Grolet

Ø mm 40×25 h
~ 20 ml
30 impronte / indents



Pavoflex 400×300 mm
Mini-portions

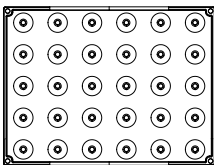

PX43100
Kupola

Ø mm 34×30 h
~ 20 ml
30 impronte / indents



Pavoflex 400×300 mm
Mini-portions

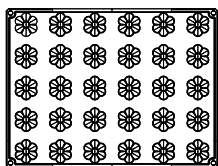

PX43101
Margherita
by Antonio Bachour

Ø mm 40×20 h
~ 20 ml
30 impronte / indents



Pavoflex 400×300 mm
Mini-portions

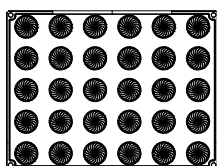

PX43102
Caledon

Ø mm 40×20 h
~ 20 ml
30 impronte / indents



Pavoflex 300×175 mm
40time

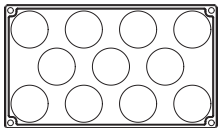

PX3221
Muffin40time
by Antonio Bachour

Ø mm 50×28 h
~ 40 ml
11 impronte / indents



Gourmand 300×175 mm

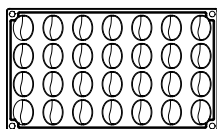

GG066
Mini Coffee
by Fabrizio Fiorani

mm 32×24×13 h
~ 6 ml
28 impronte / indents



Foo'd 300×175 mm

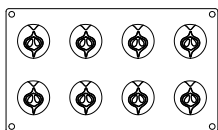

GG068
Half Apple
by Davide Oldani

mm 58×55×22 h
~ 50 ml
8 impronte / indents



Foo'd 300x175 mm

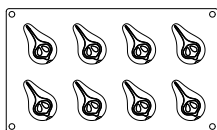

GG069
Half Pear
by Davide Oldani

mm 75x54x22 h
~ 50 ml
8 impronte / indents



Foo'd 300×175 mm

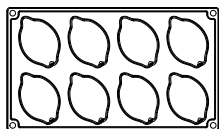

GG070
Half Lemon
by Davide Oldani

mm 77×52×22 h
~ 50 ml
8 impronte / indents



Foo'd 300x175 mm

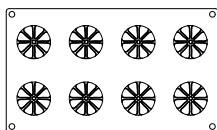

GG071
Half Orange
by Davide Oldani

Ø mm 60x22 h
~ 50 ml
8 impronte / indents



Gourmand 300×200 mm

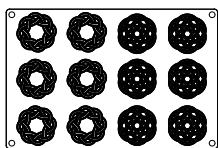

GG073
Optique
by Paolo Griffa

Ø mm 55×2 h
6+6 impronte / indents



Gourmand 310×160 mm



GG072
Me & You
by Paolo Griffa

Ø mm 140×2 h
2 impronte / indents



Gourmand 310×160 mm

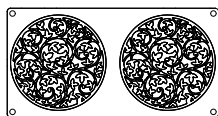

GG074
Garden
by Paolo Griffa

Ø mm 140×2 h
2 impronte / indents



Gourmand 310×160 mm



GG075
Floreale
by Paolo Griffa

mm 140×153×2 h
2 impronte / indents

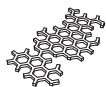

Gourmand 300×200 mm

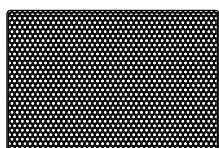

GG067
Honey pattern
by Paolo Griffa

mm 300×200×3 h



Viennoiserie



XF59

mm 120×50×45 h

Pasticceria
Pastry World





Stampi in silicone
Silicone moulds

Stampi per monoporzioni
Single-serving portions moulds

Dalle forme più classiche a
quelle più originali; in pochissimi
gesti dessert unici e facilmente
interpretabili.

From the most classic to the
most original shapes; in just a
few gestures, unique and easily
interpretable desserts.



Pavoflex 400×300 mm

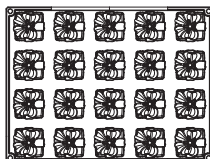

PX4395

For you

mm 55×55×55 h

~ 120 ml

20 impronte / indents

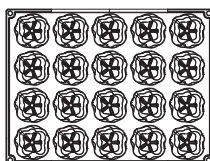

PX4396

Snow tree

Ø mm 65×75 h

~ 100 ml

20 impronte / indents

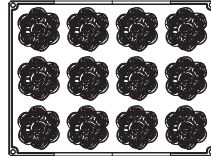

PX4397
Bouquet de roses
by Cédric Grolet

Ø mm 80×35 h
~ 100 ml
12 impronte / indents

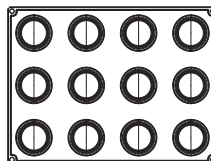

PX4393
Cylindra
by Pierre Hermé

Ø mm 65×45 h
~ 130 ml
12 impronte / indents

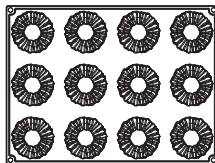

PX4391
Charlotte
by Cédric Grolet

Ø mm 75×45 h
~ 140 ml
12 impronte / indents

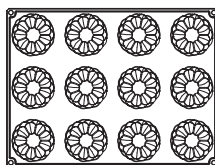

PX4392
Nuage
by Cédric Grolet

Ø mm 75×45 h
~ 140 ml
12 impronte / indents

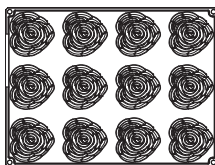

PX4390
Je t'aime
by Cédric Grolet

mm 80×80×33 h
~ 140 ml
12 impronte / indents

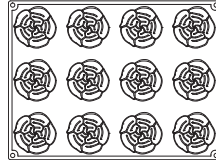

PX4388
Dentelle
by Cédric Grolet

Ø mm 75×45 h
~ 130 ml
12 impronte / indents

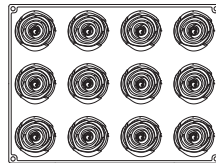

PX4386
La vie en rose
by Cédric Grolet

Ø mm 78×26 h
~ 100 ml
12 impronte / indents

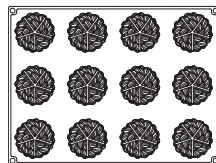

PX4384
Façon Saint-Honoré
by Cédric Grolet

Ø mm 72×40 h
~ 100 ml
12 impronte / indents



Pavoflex 400×300 mm

Per crostate monoporzione /
For single-serving tarts

Abbinabili alla fascia microforata XF7020 /
Combined with the micro-perforated band XF7020

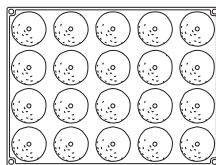

PX4359
Citron
by Cédric Grolet

Ø mm 60×37 h
~ 65 ml
20 impronte / indents

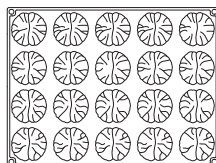

PX4357
Marron
by Cédric Grolet

Ø mm 60×35 h
~ 65 ml
20 impronte / indents

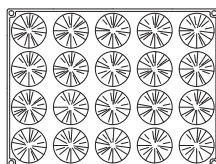

PX4358
Noisette
by Cédric Grolet

Ø mm 60×35 h
~ 65 ml
20 impronte / indents

Pavoduo 300×175 mm

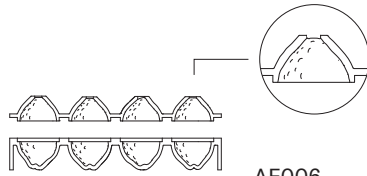

AF006
Citron
by Cédric Grolet

Ø mm 53×70 h
~ 85 ml
8 impronte / indents

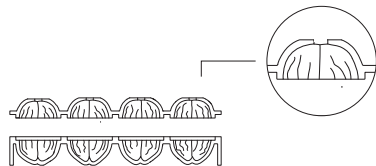

AF007
Marron
by Cédric Grolet

Ø mm 53×55 h
~ 85 ml
8 impronte / indents

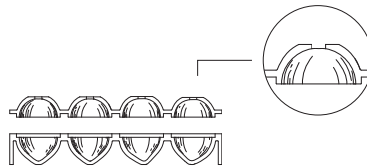

AF008
Noisette
by Cédric Grolet

Ø mm 54×60 h
~ 82 ml
8 impronte / indents



Pavoflex 400×300 mm

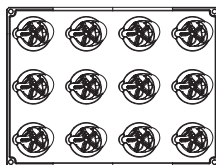

PX4389
Santa Claus

mm 60×72×70 h
~ 128 ml
12 impronte / indents

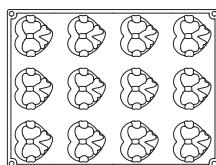

PX4385
Cadeau

mm 73×66×36 h
~ 90 ml
12 impronte / indents

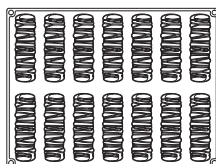

PX4387
Sequoia

mm 124×35×30 h
~ 90 ml
14 impronte / indents

Stampi in silicone / Silicone moulds



Kit stampo in silicone 400x300 mm
+stampo in silicone 300x175 mm /
Kit silicone mould 400x300 mm
+silicone mould 300x175 mm

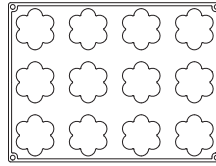

PX4383S
Margherita
by Antonio Bachour

+

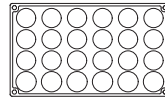

mm 75x68x26 h
~ 85 ml
12 impronte / indents



PX4353S
Pastel
by Antonio Bachour

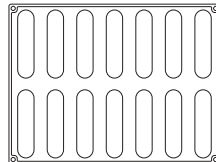

mm 125x28x28 h
~ 90 ml
14 impronte / indents

Coppapasta incluso /
Cutter included

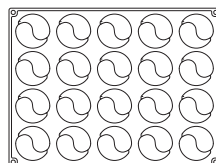

PX4375
Yoga
by Antonio Bachour

Ø mm 60x42 h
~ 102 ml
20 impronte / indents

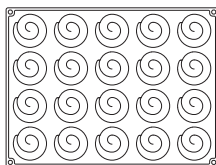

PX4374
Nautilus
by Antonio Bachour

Ø mm 60×40 h
~ 106 ml
20 impronte / indents

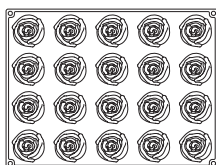

PX4376
Romance
by Antonio Bachour

mm 56×54×61 h
~ 106 ml
20 impronte / indents

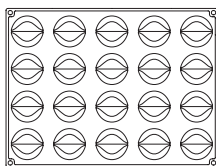

PX4365
Tulip
by Antonio Bachour

Ø mm 55×56 h
~ 90 ml
20 impronte / indents

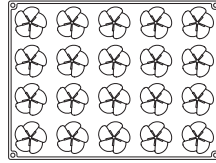

PX4371
Lotus
by Antonio Bachour

Ø mm 57×63 h
~ 105 ml
20 impronte / indents

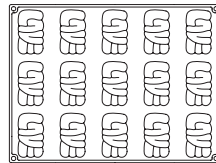

PX4363
Lovely
by Antonio Bachour

mm 80×43×36 h
~ 90 ml
15 impronte / indents

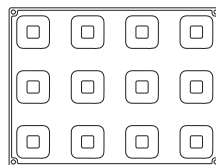
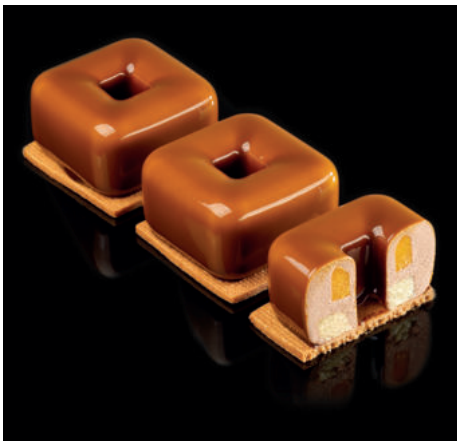

PX4361
Tulum
by Antonio Bachour

mm 56×56×34 h
~ 90 ml
12 impronte / indents

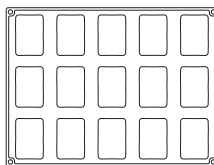

PX4364
Gummy
by Antonio Bachour

mm 74×50×27 h
~ 90 ml
15 impronte / indents

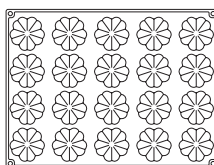

PX4362
Gel
by Antonio Bachour

Ø mm 60×63 h
~ 90 ml
20 impronte / indents

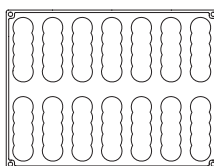

PX4360S
Miami
by Antonio Bachour

mm 118×33×42 h
~ 90 ml
14 impronte / indents

Coppapasta incluso /
Cutter included

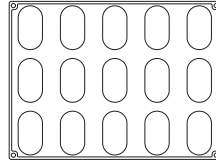

PX4356
Delish
by Antonio Bachour

mm 82×44×37 h
~ 100 ml
15 impronte / indents

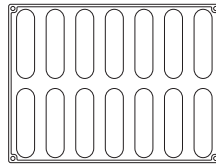

PX4351S
Confy
by Antonio Bachour

mm 128×30×28 h
~ 90 ml
14 impronte / indents

Coppapasta incluso /
Cutter included

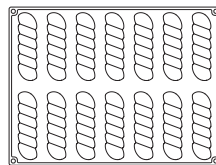

PX4373
Domino
by Antonio Bachour

mm 126×33×32 h
~ 80 ml
14 impronte / indents

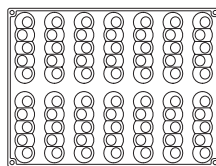

PX4352S
Pelota
by Antonio Bachour

mm 130×32×28 h
~ 90 ml
14 impronte / indents

Coppapasta incluso /
Cutter included

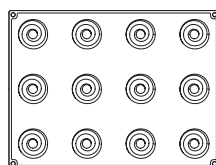

PX4340
Over
by Antonio Bachour

Ø mm 65×50 h
~ 90 ml
12 impronte / indents

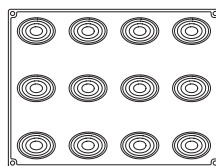

PX4341
Polly
by Antonio Bachour

mm 78×56×43 h
~ 90 ml
12 impronte / indents

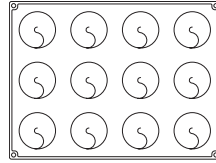

PX4355
Jasmine
by Antonio Bachour

Ø mm 65×57 h
~ 100 ml
12 impronte / indents

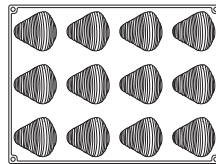

PX4377S
Sfogliatella
by Giuseppe Amato

mm 77×71,5×35 h
~ 90 ml
12 impronte / indents

Coppapasta incluso /
Cutter included

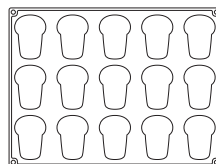
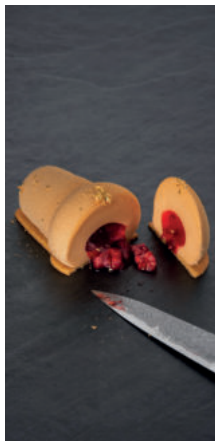

PX4382S
Babà

mm 78×54×46 h
~ 96 ml
15 impronte / indents

Coppapasta incluso /
Cutter included

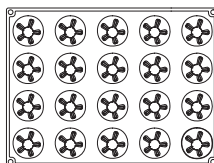

PX4329
Pear
 by Emmanuele Forcone
 Ø mm 53×70 h
 ~ 90 ml
 20 impronte / indents

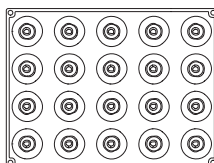

PX4330
Apple
 by Emmanuele Forcone
 Ø mm 55×48 h
 ~ 90 ml
 20 impronte / indents

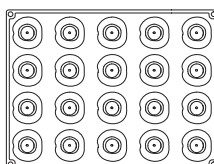

PX4331
Cherry/Peach
 by Emmanuele Forcone
 mm 58×53×46 h
 ~ 90 ml
 20 impronte / indents

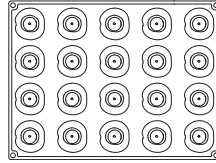

PX4331
Cherry/Peach
by Emmanuele Forcone

mm 58×53×46 h
~ 90 ml
20 impronte / indents

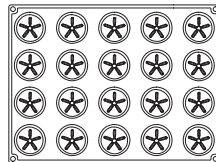

PX4332
Tangerine
by Emmanuele Forcone

Ø mm 57×50 h
~ 90 ml
20 impronte / indents

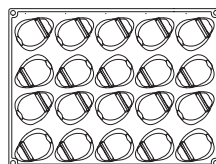

PX4333
Strawberry
by Emmanuele Forcone

mm 71×54×46 h
~ 90 ml
20 impronte / indents



PX4370S
Beloved
by Emmanuele Forcone

mm 127×71×38 h
~ 200 ml
9 impronte / indents

Coppapasta incluso
Cutter included

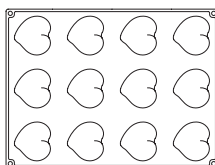
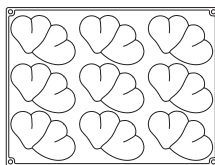

PX4305
Passion

mm 71×66×38 h
~ 100 ml
12 impronte / indents

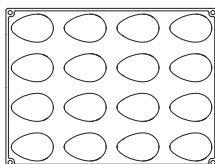

PX4369
Mono Quenelle

mm 77×51×42 h
~ 90 ml
16 impronte / indents



Guarda il video sul canale Youtube di Pavoni Italia / Watch the video on Pavoni Italia's Youtube channel



PX4335S
Square
by Gianluca Fusto

mm 68×68×15 h
~ 68 ml
12 impronte / indents

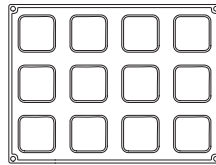

Il kit include /
The kit includes:
coppapasta inserimento
insert cutter mm 53×53
coppapasta biscotto
cookie cutter mm 93×93



PX4337S
Rectangular
by Gianluca Fusto

mm 92×50×15 h
~ 67 ml
12 impronte / indents

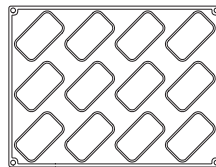

Il kit include /
The kit includes:
coppapasta inserimento
insert cutter mm 77×35
coppapasta biscotto
cookie cutter mm 117×75

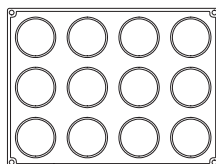

PX4334S
Round
by Gianluca Fusto

Ø mm 74×15 h
~ 64 ml
12 impronte / indents

Il kit include / the kit includes: coppapasta inserimento / insert cutter Ø mm 59
coppapasta biscotto / cookie cutter Ø mm 99

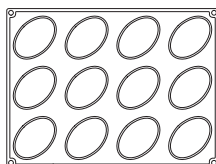

PX4336S
Oval
by Gianluca Fusto

mm 93×62×15 h
~ 67 ml
12 impronte / indents

Il kit include / the kit includes: coppapasta inserimento / insert cutter mm 79×35
coppapasta biscotto / cookie cutter mm 118×87

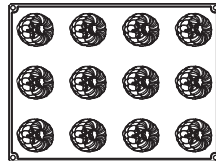

PX4394
Lampone 1.1
by Fabrizio Fiorani

mm 65×58×54 h
~ 95 ml
12 impronte / indents

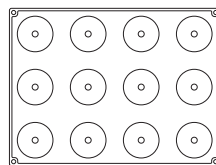

PX4349
Loop

Ø mm 65×34 h
~ 90 ml
12 impronte / indents

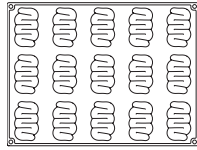

PX4342
Turn

mm 80×46×38 h
~ 100 ml
15 impronte / indents

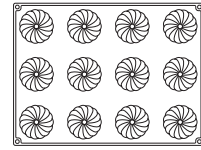

PX4372
Gnammy

Ø mm 68×34 h
~ 90 ml
12 impronte / indents

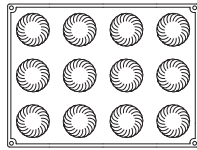

PX4317
Caleidon

Ø mm 66×34 h
~ 93 ml
12 impronte / indents

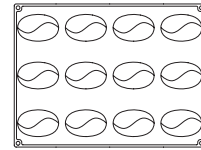

PX4304
Curvy

mm 83×53×42 h
~ 100 ml
12 impronte / indents

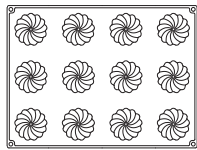

PX4308
Delice

Ø mm 64×52 h
~ 100 ml
12 impronte / indents

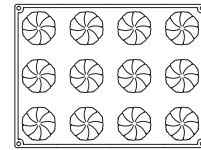

PX4322
Twister

Ø mm 66×35 h
~ 88 ml
12 impronte / indents

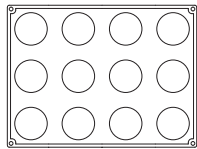

PX4321
Planet

Ø mm 66×34 h
~ 93 ml
12 impronte / indents

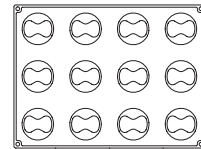

PX4307
Moon

Ø mm 61×50 h
~ 100 ml
12 impronte / indents

Stampi in silicone / Silicone moulds

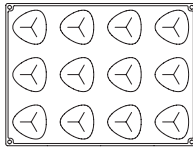

PX4303
Natural

mm 69×68×52 h
~ 100 ml
12 impronte / indents

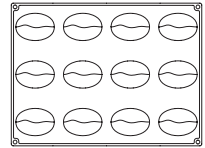

PX4312
Moka

mm 83×58×32 h
~ 100 ml
12 impronte / indents

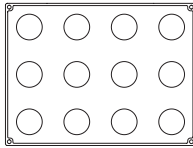

PX4302
Drop

Ø mm 66×47 h
~ 100 ml
12 impronte / indents

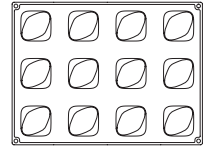

PX4306
Decò

mm 58×58×40 h
~ 100 ml
12 impronte / indents

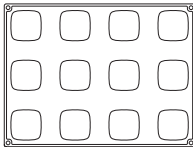
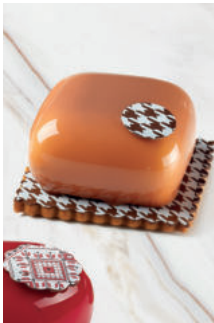

PX4343
Mister

mm 58×58×33 h
~ 90 ml
12 impronte / indents

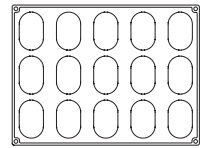

PX4345
Miss

mm 78×48×33 h
~ 90 ml
15 impronte / indents

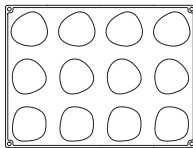

PX4301
Zen

Ø mm 68×32 h
~ 100 ml
12 impronte / indents



Pavoflex 600×400 mm

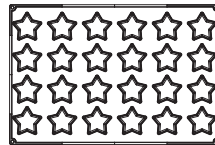

PX083
Star

mm 80×80×40 h
~ 100 ml
24 impronte / indents

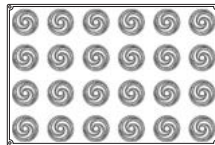

PX039
Bocciolo

Ø mm 70×42 h
~ 130 ml
24 impronte / indents

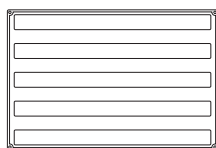

PX060
Tronchetto Mono

Ø mm 40×560
~ 600 ml
5 impronte / indents

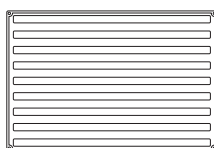

PX058
Tronchetto Mignon

mm 18×560
~ 124 ml
9 impronte / indents

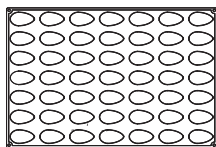

PX073
Quenelle Tonda

mm 66×35×26 h
~ 34 ml
49 impronte / indents

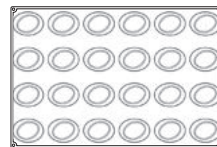

PX064
Wave

mm 83×62×35 h
~ 130 ml
24 impronte / indents

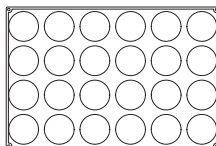

PX078
Daisy

Ø mm 74×15 h
~ 65 ml
24 impronte / indents

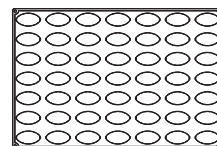

PX071
Quenelle

mm 66×33×30 h
~ 32 ml
49 impronte / indents

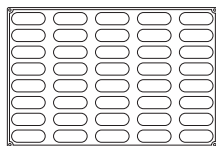

PX068
Gianduiotto

mm 90×30×53 h
~ 83 ml
40 impronte / indents

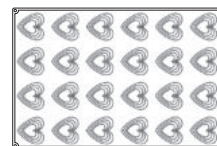

PX032
Love

mm 78×77×34 h
~ 110 ml
24 impronte / indents

Stampi in silicone / Silicone moulds

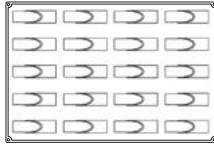

PX024
Flow

mm 120×33×32 h
~ 100 ml
20 impronte / indents

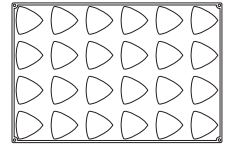

PX066
Trilo

mm 75×72×58 h
~ 96 ml
24 impronte / indents

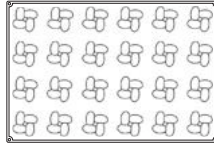

PX016
Intrigo

Ø mm 70×42 h
~ 100 ml
24 impronte / indents

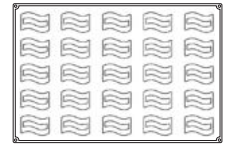
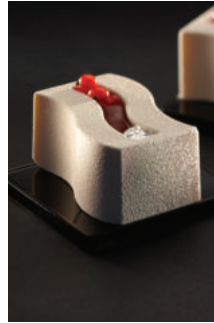

PX023
Ondina

mm 80×45×40 h
~ 130 ml
25 impronte / indents

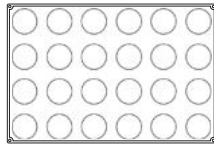

PX001
Semisfera

Ø mm 70×40 h
~ 120 ml
24 impronte / indents

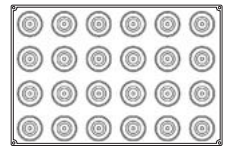

PX034
Ring

Ø mm 70×50 h
~ 110 ml
24 impronte / indents

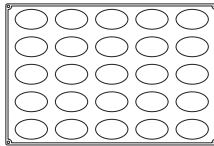
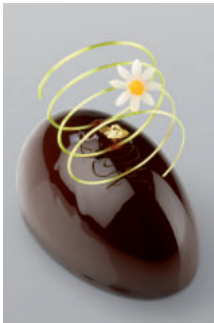

PX067
Oval

mm 85×50×43 h
~ 100 ml
25 impronte / indents

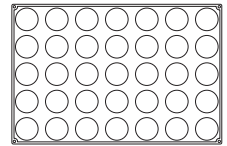

PX065
Kupola

Ø mm 60×58 h
~ 110 ml
35 impronte / indents

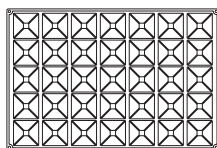

PX004
Piramide

mm 70×70×45 h
~ 80 ml
35 impronte / indents

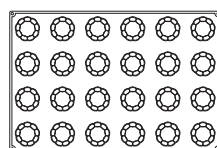

PX051
Charlotte

Ø mm 65×38 h
~ 105 ml
24 impronte / indents

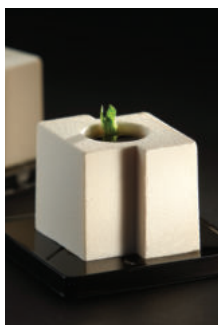

PX030
Tekno

mm 58×50×50 h
~ 115 ml
24 impronte / indents

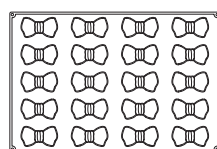

PX052
Papillon

mm 100×52×35 h
~ 105 ml
20 impronte / indents

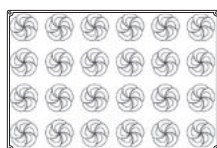

PX063
Spirale

Ø mm 75×38 h
~ 130 ml
24 impronte / indents

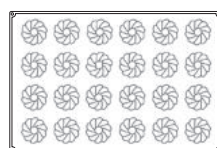

PX018
Fantasia

Ø mm 75×48 h
~ 120 ml
24 impronte / indents

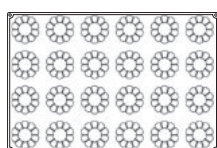

PX003
Briochette

Ø mm 79×37 h
~ 100 ml
24 impronte / indents

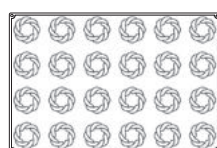

PX040
Intreccio

Ø mm 70×40 h
~ 130 ml
24 impronte / indents

Stampi in silicone / Silicone moulds

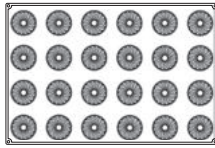

PX014
Guglhupf

Ø mm 70×33 h
~ 70 ml
24 impronte / indents



PX015
Trittico

mm 120×32×32 h
~ 115 ml
20 impronte / indents

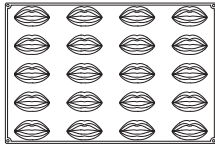

PX054
Bocca

mm 93×50×36 h
~ 105 ml
20 impronte / indents



PX025
Soft

mm 120×32×38 h
~ 115 ml
20 impronte / indents

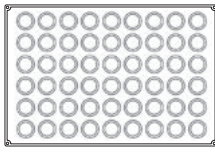

PX005
Mini Muffin

Ø mm 50×28 h
~ 45 ml
54 impronte / indents

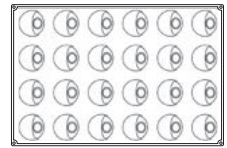

PX029
Eclisse

Ø mm 72×41 h
~ 110 ml
24 impronte / indents

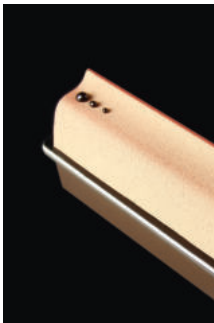

PX035
Move

mm 120×35×36 h
~ 110 ml
20 impronte / indents

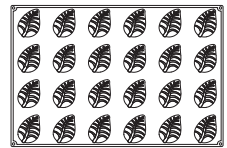

PX055
Foglia

mm 86×56×38 h
~ 105 ml
24 impronte / indents

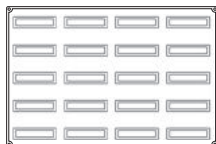
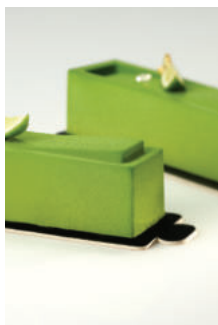

PX027
Libra

mm 120×30×35 h
~ 110 ml
20 impronte / indents

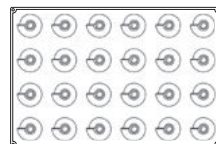
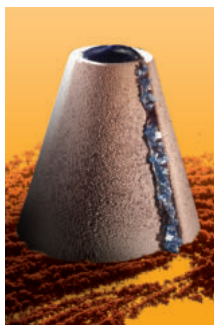

PX021
Cono

Ø mm 65×65 h
~ 125 ml
24 impronte / indents



PX042
Twist

mm 122×32×33 h
~ 100 ml
20 impronte / indents

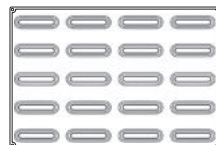

PX036
Round

mm 123×35×32 h
~ 100 ml
20 impronte / indents



PX007
Cubo

mm 50×50×50 h
~ 115 ml
28 impronte / indents

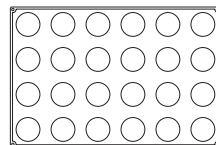

PX057
Cilindro

Ø mm 65×40 h
~ 130 ml
24 impronte / indents

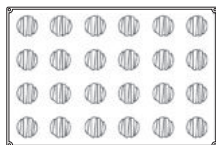

PX019
Rigo

Ø mm 60×45 h
~ 115 ml
24 impronte / indents

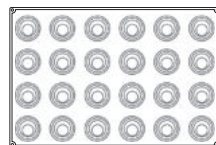

PX010
Babele

Ø mm 68×50 h
~ 130 ml
24 impronte / indents

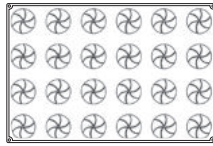

PX033
Vertigo

Ø mm 70×44 h
~ 110 ml
24 impronte / indents

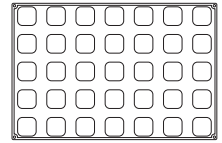

PX070
Tango

mm 50×50×58 h
~ 130 ml
35 impronte / indents

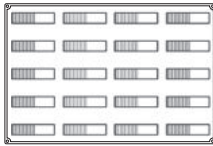

PX026
Log

mm 120×30×32 h
~ 110 ml
20 impronte / indents

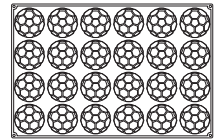

PX307
Pallone

Ø mm 80×45 h
~ 150 ml
24 impronte / indents

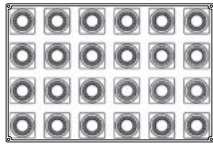

PX041
Caesar

mm 70×70×50 h
~ 130 ml
24 impronte / indents

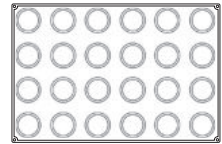

PX002
Muffin

Ø mm 70×40 h
~ 130 ml
24 impronte / indents

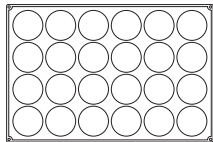

PX056
Big Muffin

Ø mm 85×50 h
~ 235 ml
24 impronte / indents

Pavoflex 300×175 mm

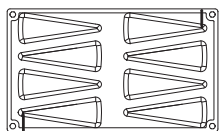

PX3214S
Slake
by Nicolas Bacheyre

mm 114×39×20 h
~ 50 ml
8 impronte / indents

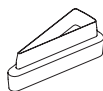

Coppapasta incluso /
cutter included



PX3200
Round
by Gianluca Fusto

Ø mm 60×20 h
~ 48 ml
8 impronte / indents

Abbinabile a /
combined with XF7020

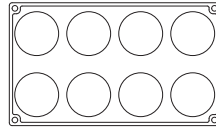

PX3201
Shell
by Gianluca Fusto

mm 86×41×22 h
~ 43 ml
9 impronte / indents

Abbinabile a /
combined with XF11

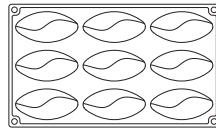

PX3202
Cameo
by Gianluca Fusto

mm 81×41×19 h
~ 42 ml
9 impronte / indents

Abbinabile a /
combined with XF12

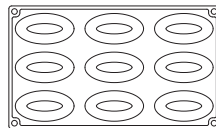

PX3203
Spring
by Gianluca Fusto

mm 84×41×20 h
~ 50 ml
9 impronte / indents

Abbinabile a /
combined with XF13

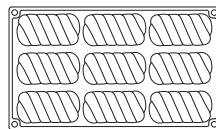



PX3204
Sand
by Gianluca Fusto

mm 115×24×20 h
~ 38 ml
10 impronte / indents

Abbinabile a /
combined with XF15

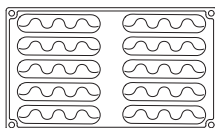

PX3205
Pyramid
by Gianluca Fusto

mm 66×60×28 h
~ 46 ml
8 impronte / indents

Abbinabile a /
combined with XF16

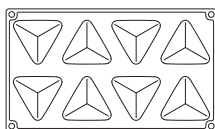

PX3206
Heart
by Gianluca Fusto

mm 65×60×21 h
~ 46 ml
8 impronte / indents

Abbinabile a /
combined with XF14

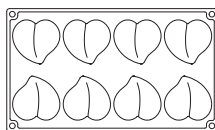

PX3207
Rock
by Gianluca Fusto

mm 55×55×23 h
~ 54 ml
8 impronte / indents

Abbinabile a /
combined with
XFO656520

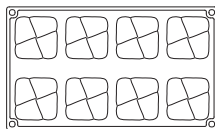

Stampi in silicone / Silicone moulds



PX3208
Frisbee
by Gianluca Fusto

Ø mm 60×28 h
~ 48 ml
8 impronte / indents

Abbinabile a /
combined with XF7020

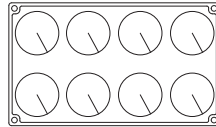

PX3209
Charm
by Gianluca Fusto

Ø mm 60×21,5 h
~ 46 ml
8 impronte / indents

Abbinabile a /
combined with XF7020

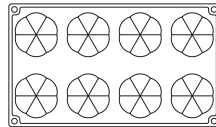

PX3210
Step
by Gianluca Fusto

Ø mm 60×32 h
~ 49,5 ml
8 impronte / indents

Abbinabile a /
combined with XF7020

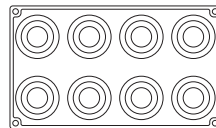

PX3211
Pill
by Gianluca Fusto

mm 117×24,5×19,5 h
~ 40 ml
10 impronte / indents

Abbinabile a /
combined with XF15

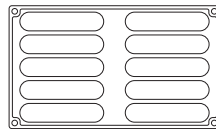



Stampi in silicone
Silicone moulds

Stampi per medie porzioni
Medium portions moulds

40time
La rivoluzione è nel formato: 40 ml
Cambia look alle tue creazioni
per teatime, catering, banqueting,
wedding e dessert al piatto. La media
porzione perfetta in sette forme
accattivanti.

40time
The revolution is in the size: 40 ml
Change the look to teatime,
catering, banqueting, weddings
and plated desserts. The perfect
medium portion in seven charming
shapes.



Pavoflex 300×175 mm

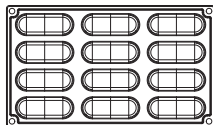

PX3215
Pastel40time
by Antonio Bachour

mm 80×27×21 h
~ 40 ml
12 impronte / indents

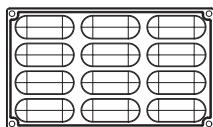

PX3216
Confy40time
by Antonio Bachour

mm 80×30×24 h
~ 40 ml
12 impronte / indents

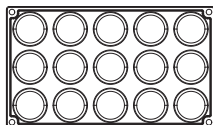

PX3217
Cylinder40time
by Antonio Bachour

Ø mm 45×28 h
~ 40 ml
15 impronte / indents



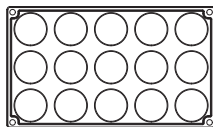
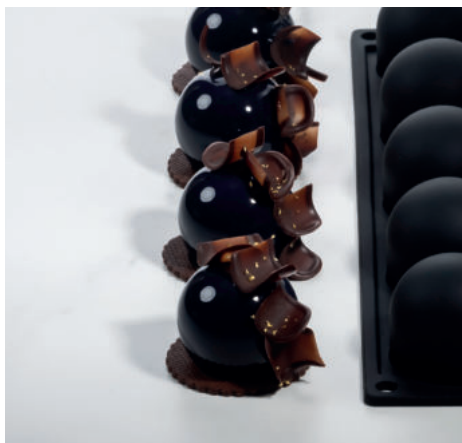

PX3218
Sphere40time
 by Antonio Bachour

Ø mm 43×39 h
 ~ 40 ml
 15 impronte / indents

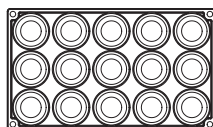

PX3219
Planet40time
 by Antonio Bachour

Ø mm 50×26 h
 ~ 40 ml
 15 impronte / indents

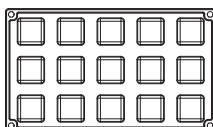

PX3220
Cube40time
 by Antonio Bachour

mm 34×34×34 h
 ~ 40 ml
 15 impronte / indents

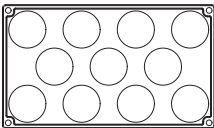

PX3221
Muffin40time
by Antonio Bachour

Ø mm 50×28 h
~ 40 ml
11 impronte / indents



Stampi in silicone
Silicone moulds

Stampi per miniporzioni
Mini-portions moulds

Il design “made in Pavoni Italia”
in pochi grammi.

The design “made in Pavoni Italia”
in just a few grams.



Pavoflex 400×300 mm

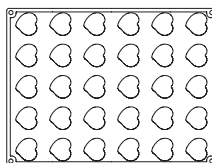

PX4325
Passion

mm 40×30×20 h
~ 18 ml
30 impronte / indents

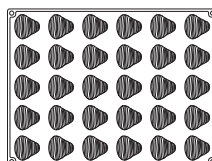

PX4378
Sfogliatella
by Giuseppe Amato

mm 45×43,5×22 h
~ 20 ml
30 impronte / indents

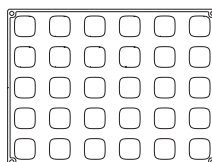

PX4346
Mister Mignon

mm 35×35×20 h
~ 18 ml
30 impronte / indents

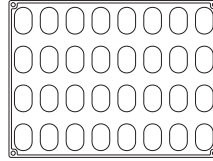

PX4348
Miss Mignon

mm 46×28×20 h
~ 18 ml
32 impronte / indents

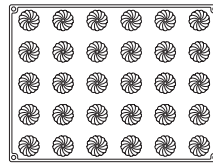

PX4324
Delice

Ø mm 36×29 h
~ 18 ml
30 impronte / indents

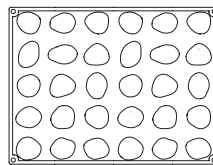

PX4326
Zen

dimensioni varie
different shapes
~ 18 ml
30 impronte / indents

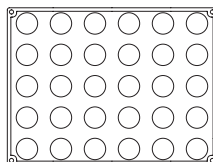

PX4323
Planet

Ø mm 38×20 h
~ 18 ml
30 impronte / indents



Pavoflex 600×400 mm

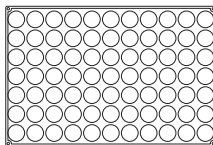

PX303
Semisfera

Ø mm 42×21 h
~ 20 ml
77 impronte / indents

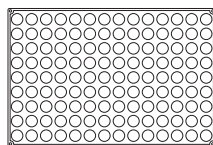

PX304
Semisfera

Ø mm 30×18 h
~ 10 ml
126 impronte / indents

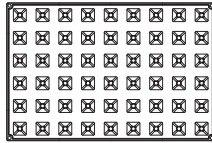

PX079
Mini pyramid

mm 36×36×22 h
~13 ml
54 impronte / indents

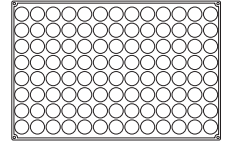

PX302
Pomponette

Ø mm 36×17 h
~ 15 ml
104 impronte / indents

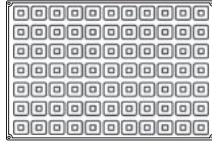

PX046
Savarin Mignon

mm 38×38×13 h
~ 14 ml
77 impronte / indents

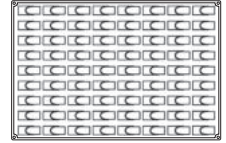

PX047
Flow Mignon

mm 60×24×23 h
~ 25 ml
72 impronte / indents

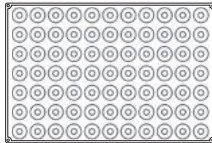

PX045
Savarin Mignon

Ø mm 40×13 h
~ 13 ml
77 impronte / indents



PX017
Intrigo Mignon

Ø mm 40×28 h
~ 25 ml
54 impronte / indents

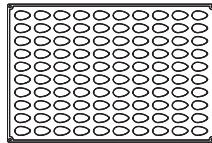

PX074
Mini Quenelle Tonda

mm 42×22×17 h
~ 9 ml
100 impronte / indents

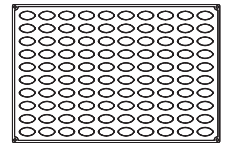

PX072
Mini Quenelle

mm 42×20×20 h
~ 8 ml
100 impronte / indents



PX012
Cubo Mignon

mm 30×30×30 h
~ 25 ml
54 impronte / indents



PX013
Cilindro Mignon

Ø mm 35×35 h
~ 25 ml
54 impronte / indents

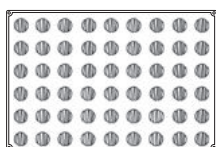

PX020
Rigo Mignon

Ø mm 35×30 h
~ 25 ml
54 impronte / indents

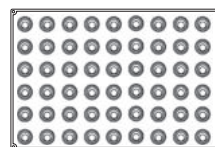

PX011
Babele

Ø mm 40×30 h
~ 25 ml
54 impronte / indents

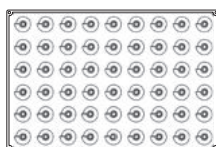

PX022
Cono Mignon

Ø mm 40×43 h
~ 30 ml
54 impronte / indents

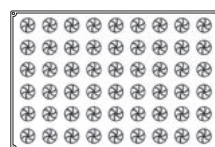

PX048
Vertigo Mignon

Ø mm 40×27 h
~ 25 ml
54 impronte / indents



PX044
Round Mignon

mm 60×24×23 h
~ 25 ml
72 impronte / indents

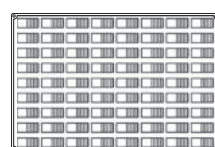
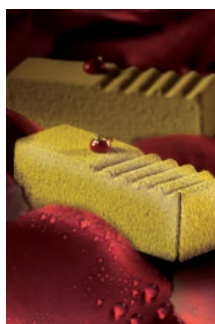

PX043
Log Mignon

mm 60×24×21 h
~ 29 ml
72 impronte / indents

Stampi in silicone / Silicone moulds

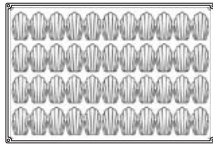

PX006
Madeleine

mm 78×45×18 h
~ 35 ml
44 impronte / indents

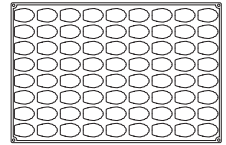

PX305
Mini Madeleine

mm 52×33×15 h
~ 15 ml
72 impronte / indents

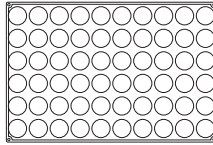

PX301
Mini Tartellette

Ø mm 48×15 h
~ 21 ml
60 impronte / indents

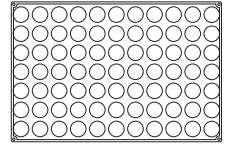

PX300
Petit Four

Ø mm 40×20 h
~ 22 ml
77 impronte / indents

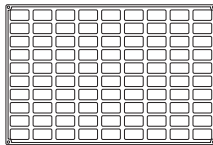

PX306
Mini Finanziere

mm 49×26×11 h
~ 11 ml
90 impronte / indents



Stampi in silicone
Silicone moulds

Stampi per sfere
Sphere moulds

La forma perfetta in dimensioni
diverse per ogni utilizzo.

The perfect shape in different sizes
for every use.



Pavoflex 400×300 mm

Dimensioni diverse, da 15 a 60 mm di diametro, per preparare sezioni di sfere da decorare e utilizzare per impreziosire le tue preparazioni. / Various sizes, from 15 to 60 mm in diameter, to prepare sections of spheres that you can decorate and use to embellish your creations.

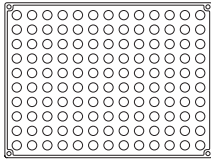

PX4339

Ø mm 15
~ 2 ml
130 impronte / indents

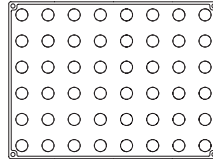

PX4314

Ø mm 20
~ 4 ml
48 impronte / indents

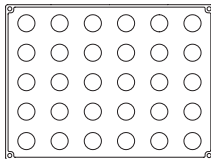

PX4313

Ø mm 30
~ 14 ml
30 impronte / indents

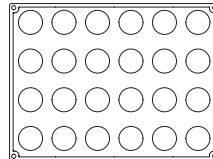

PX4315

Ø mm 40
~ 33 ml
24 impronte / indents

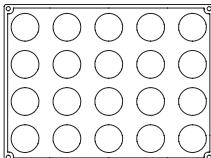

PX4316

Ø mm 50
~ 65 ml
20 impronte / indents

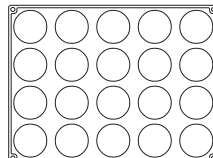

PX4350

Ø mm 60
~ 110 ml
20 impronte / indents

Pavoduo 300×175 mm

Stampi in due parti per la preparazione di sfere perfette, da 25 a 55 mm di diametro. L'effetto 3D è totale, grazie alla concezione innovativa dello stampo, per sfere davvero "a tutto tondo": la gamma da AF001 a AF005 è dotata di foro per il riempimento e per il posizionamento dello stecco con LS05. / Two/part moulds for preparing perfect spheres, from 25 to 55 mm in diameter. The 3D effect is total, thanks to the innovative mould design, for truly 'all/round' spheres: the AF001 to AF005 range is equipped with a hole for filling and for positioning the stick with LS05.

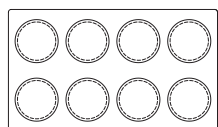
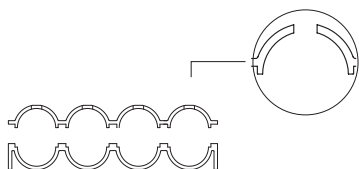

AF001

Ø mm 55
~ 87 ml
8 impronte / indents

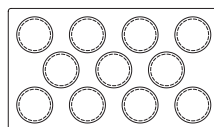

AF002

Ø mm 45
~ 48 ml
11 impronte / indents

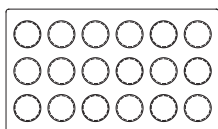

AF003

Ø mm 35
~ 22,5 ml
18 impronte / indents

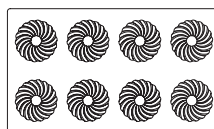

AF004

Ø mm 55
~ 83 ml
8 impronte / indents

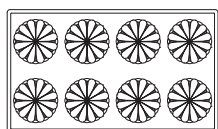

AF005

Ø mm 55
~ 80 ml
8 impronte / indents

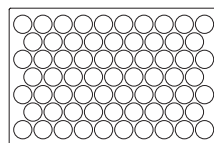

LS05

Ø mm 25
~ 8 ml
67 impronte / indents
Dim. stampo / mould
mm 290×190





Stampi in silicone *Silicone moulds*

Formaflex

Stampi Formaflex 300×175 mm pari ad un terzo di Gastronorm e ad un quarto delle teglie da pasticceria, per garantire la massima produttività e la migliore compatibilità con le attrezzature professionali.

The Formaflex 300×175 mm moulds are a third of Gastronorm and a quarter of pastry trays to guarantee maximum productivity and the best compatibility with professional equipment.



FR001
Semisfera / hemisphere
Ø mm 70×35 h
~ 89 ml
6 impronte / indents



FR002
Babà
Ø mm 55×60 h
~ 97 ml
8 impronte / indents

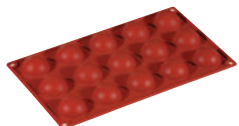

FR003
Semisfera / hemisphere
Ø mm 40×20 h
~ 17 ml
15 impronte / indents



FR004
Semisfera / hemisphere
Ø mm 30×17 h
~ 8,5 ml
24 impronte / indents

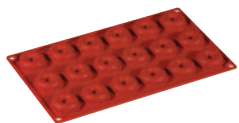

FR005
Mini savarin
Ø mm 41×12 h
~ 12 ml
18 impronte / indents



FR006
Pomponette
Ø mm 34×16 h
~ 13 ml
24 impronte / indents



FR007
Pyramid
mm 71×71×40 h
~ 92 ml
6 impronte / indents



FR008
Muffin
Ø mm 70×40 h
~ 130 ml
6 impronte / indents



FR009
Ovale / oval
mm 53×33×20 h
~ 28 ml
16 impronte / indents



FR010
Savarin
Ø mm 65×21 h
~ 49 ml
8 impronte / indents

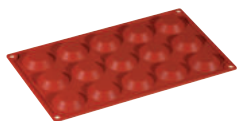

FR011
Mini tartelletta / tartlet
Ø mm 45×10 h
~ 12 ml
15 impronte / indents



FR012
Briochette
Ø mm 79×37 h
~ 100 ml
6 impronte / indents

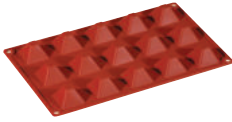

FR013
Mini pyramid
mm 36×36×22 h
~ 13 ml
15 impronte / indents



FR014
Mini financier
mm 49×26×11 h
~ 11 ml
20 impronte / indents



FR015
Savarin
Ø mm 72×23 h
~ 67 ml
6 impronte / indents



FR016
Tartelletta / tartelet
Ø mm 50×15 h
~ 20 ml
15 impronte / indents



FR017
Cilindro / cilindro
Ø mm 60×35 h
~ 89 ml
8 impronte / indents



FR018
Semisfera / hemisphere
Ø mm 80×40 h
~ 134 ml
5 impronte / indents

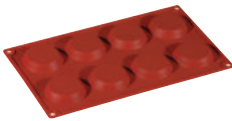

FR019
Florentine
Ø mm 60×12 h
~ 27 ml
8 impronte / indents



FR020
Mini muffin
Ø mm 50×28 h
~ 43 ml
11 impronte / indents



FR021
Madeleine
mm 68×45×18 h
~ 30 ml
9 impronte / indents



FR022
Ottagono / octagon
Ø mm 38×26 h
~ 28 ml
15 impronte / indents



FR023
Biscuit
Ø mm 103×20 h
~ 160 ml
3 impronte / indents



FR024
Petit four
Ø mm 40×20 h
~ 22 ml
15 impronte / indents



FR025
Cuore / heart
mm 65×60×35 h
~ 97 ml
8 impronte / indents



FR026
Madeleine
mm 42×30×11,5 h
~ 8 ml
20 impronte / indents



FR027
Briochette
Ø mm 79×30 h
~ 109 ml
6 impronte / indents



FR028
Cake
mm 80×30×30 h
~ 62 ml
9 impronte / indents

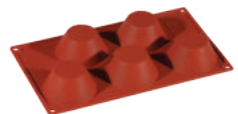

FR029
Cupcake
Ø mm 80×35 h
~ 110 ml
5 impronte / indents



FR030
Babà
Ø mm 45×48 h
~ 51 ml
11 impronte / indents



FR031
Babà
Ø mm 35×38 h
~ 25 ml
15 impronte / indents



FR032
Cannelé
Ø mm 56×50 h
~ 70 ml
8 impronte / indents



FR033
Diamante / diamond
Ø mm 35×23 h
~ 13 ml
18 impronte / indents



FR034
Diamante / diamond
Ø mm 68×45 h
~ 80 ml
6 impronte / indents



FR035
Bavarese
Ø mm 57×57 h
~ 110 ml
8 impronte / indents



FR036
Onde / waves
mm 80×45×25 h
~ 85 ml
6 impronte / indents



FR037
Mini cannelé
Ø mm 35×35 h
~ 24 ml
18 impronte / indents



FR038
Semisfera / hemisphere
Ø mm 60×30 h
~ 57 ml
8 impronte / indents



FR039
Semisfera / hemisphere
Ø mm 50×23 h
~ 33 ml
15 impronte / indents



FR040
Tartelletta / tartlet
Ø mm 60×17 h
~ 35 ml
8 impronte / indents



FR041
Ovale / oval
mm 65×41×34 h
~ 52 ml
9 impronte / indents



FR045
Margherita / Daisy
Ø mm 68×27 h
~ 75 ml
6 impronte / indents



FR046
Guglhupf
Ø mm 60×33 h
~ 70 ml
6 impronte / indents



FR047
Cake
Ø mm 80×18 h
~ 85 ml
6 impronte / indents



FR048
Cabosside
mm 76×46×23 h
~ 30 ml
6 impronte / indents



FR049
Savarin ovale / oval
mm 80×60×25 h
~ 74 ml
6 impronte / indents



FR050
Zucche / pumpkins
mm 72×61×28 h
~ 60 ml
6 impronte / indents



FR052
Rose
Ø mm 75×40 h
~ 90 ml
6 impronte / indents



FR053
Semisfera / hemisphere
Ø mm 75×43 h
~ 128 ml
6 impronte / indents



FR056RSA
Rose
Ø mm 70×37 h
~ 100 ml
6 impronte / indents



FR064
Cuore / heart
mm 60×75×67 h
~ 110 ml
8 impronte / indents



FR065
Muffin
Ø sup mm 50
Ø inf mm 70
mm 35 h
~ 100 ml
6 impronte / indents



FR068
Torroncino
mm 50×25×20 h
~ 25 ml
20 impronte / indents



FR069
Guglhupf
Ø mm 52×32 h
~ 50 ml
8 impronte / indents



FR071
Mini savarin mix
mm 40×36×12 h
~ 8 ml
18 impronte / indents



FR073
Micro savarin
tondo / round
Ø mm 30×13,5 h
~ 7,5 ml
28 impronte / indents



FR074
Micro savarin
ovale / oval
mm 35×25×13,5 h
~ 7,5 ml
28 impronte / indents



FR075
Micro savarin
quadrato / square
mm 30×30×13,5 h
~ 9,5 ml
28 impronte / indents



FR076
Micro savarin
triangolare / triangular
mm 30×30×13,5 h
~ 6,5 ml
28 impronte / indents



FR077
Charlotte
Ø mm 78×36 h
~ 110 ml
6 impronte / indents

Stampi in silicone / Silicone moulds



FR078
St. Honorè

Ø mm 80×21 h
~ 55 ml
6 impronte / indents



FR082
Cuore

mm 68×68×31 h
~ 82 ml
8 impronte / indents



FR096
Swirl

Ø mm 75×38 h
~ 110 ml
6 impronte / indents



FR103
Cubo / cube

mm 40×40×40 h
~ 62 ml
15 impronte / indents



FR116
Florentine

Ø mm 35×5 h
~ 5 ml
24 impronte / indents

Formaflex tortiere / Formaflex cake moulds

Formaflex è ideale per sfornare torte e preparazioni dolci e salate. La sua composizione è pensata per la massima anti/aderenza, che garantisce sviluppo e lievitazione dei preparati in modo perfetto, con una resistenza garantita da -40°C a + 250°C. / Formaflex cake moulds are ideal for baking cakes as well as sweet and savoury preparations. The material has been designed for maximum non/stick effect, which ensures perfect rising and baking of your creations, with a guaranteed temperature resistance from -40°C to +250°C.



KE997
Tonda / round

Ø mm 150×50 h
~ 870 ml



KE998
Tonda / round

Ø mm 180×70 h
~ 1760 ml



KE999
Tonda / round

Ø mm 240×70 h
~ 3130 ml



FRT001
Tonda / round

Ø mm 200×40 h
~ 1150 ml



FRT002
Tonda / round

Ø mm 220×40 h
~ 1400 ml



FRT003
Tonda / round

Ø mm 240×42 h
~ 1850 ml



FRT004
Tonda / round

Ø mm 260×45 h
~ 2250 ml



FRT005
Tonda / round

Ø mm 280×45 h
~ 2600 ml



FRT051
Tonda cannellata /
cannelle round

Ø mm 260×30 h
~ 1350 ml



FRT058
Tonda cannellata /
cannelle round

Ø mm 280×30 h
~ 1700 ml



FRT053
Tonda cannellata /
cannelle round

Ø mm 300×30 h
~ 1850 ml



FRT104
Guglhupf

Ø mm 220×110 h
~ 2750 ml



FRT103
Ciambella / donut

Ø mm 240×60 h
~ 1685 ml



FRT120
Plumcake

mm 280×105×65 h
~ 1660 ml



FRT106L
Plumcake

mm 240×105×65 h
~ 1385 ml

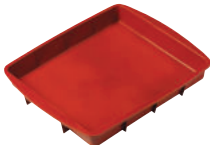

FRT077
Rettangolare /
rectangular

mm 280×240×40 h
~ 2670 ml



FRT052
Tonda cannellata /
cannelle round

Ø mm 280×30 h
~ 1600 ml



Stampi in silicone
Silicone moulds

Stampi per torte
Cakes moulds

Dalle forme classiche alle piÙ moderne, sapranno valorizzare ogni produzione.

From the classic to the most modern shapes, they will enhance every production.



Pavocake

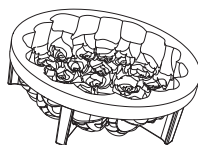

KE093
Bouquet de roses
by Cédric Grolet

Ø mm 185×60 h
~ 1100 ml

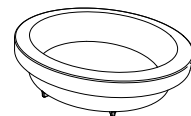

KE089
Cylindra
by Pierre Hermé

Ø mm 150×45 h
~ 700 ml

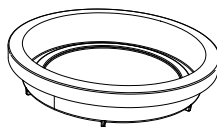

KE090
Cylindra
by Pierre Hermé

Ø mm 200×45 h
~ 1200 ml

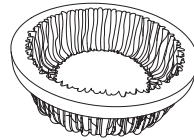

KE087
Charlotte
by Cédric Grolet

Ø mm 180×65 h
~ 1200 ml

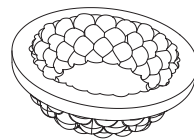

KE088
Nuage
by Cédric Grolet

Ø mm 180×65 h
~ 1200 ml



KE086
Je t'aime
by Cédric Grolet

mm 185×185×50 h
~ 1000 ml

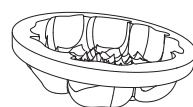

KE082
Dentelle
by Cédric Grolet

Ø mm 180×50 h
~ 1000 ml

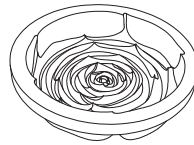

KE080
La vie en rose
by Cédric Grolet

Ø mm 180×45 h
~ 960 ml

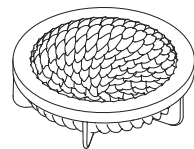
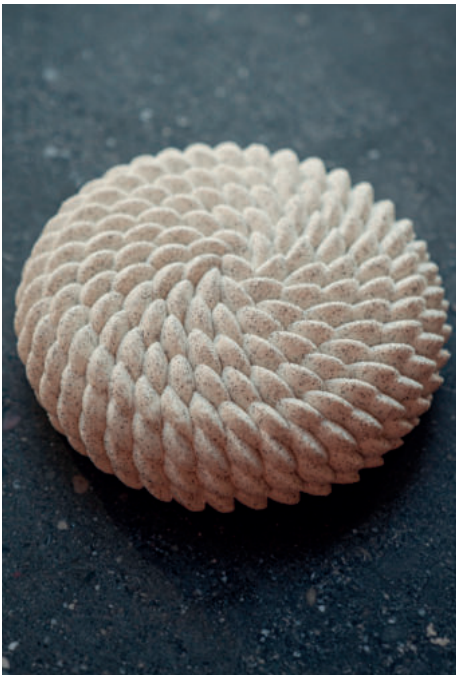

KE074
Façon
Saint-Honoré
by Cédric Grolet

Ø mm 180×56 h
~ 1000 ml

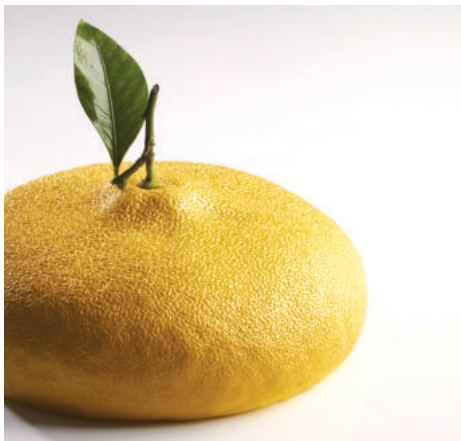

KE057
Citron
by Cédric Grolet

Ø mm 180×70 h
~ 1215 ml

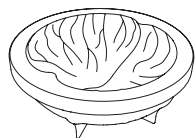

KE056
Marron
by Cédric Grolet

Ø mm 180×71 h
~ 1140 ml



KE055
Noisette
by Cédric Grolet

Ø mm 180×70 h
~ 1155 ml

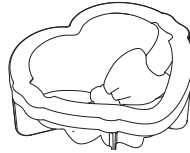

KE075
Cadeau
by Emmanuele Forcone

mm 180×162×67 h
~ 1000 ml

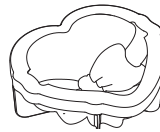

KE076
Mini Cadeau
by Emmanuele Forcone

mm 148×134×58 h
~ 600 ml

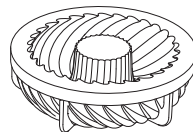

KE062
Cyclone
by Emmanuele Forcone

external Ø mm 180
internal Ø mm 55
mm 57 h
~ 1036 ml

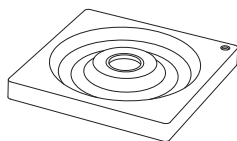

KE069S
Hula
by Emmanuele Forcone

Top
external Ø mm 170
internal Ø mm 65
mm 21 h
~ 294 ml

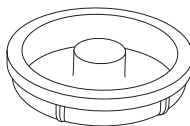

Base
external Ø mm 180
internal Ø mm 54
mm 40 h
~ 848 ml

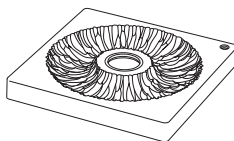

KE070S
Corolla
by Emmanuele Forcone

Top
external Ø mm 171
internal Ø mm 60
mm 21 h
~ 269 ml

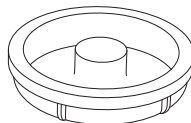

Base
external Ø mm 180
internal Ø mm 54
mm 40 h
~ 848 ml

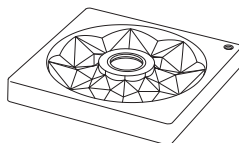

KE071S
Louvre
by Emmanuele Forcone

Top
external Ø mm 170
internal Ø mm 60
mm 23 h
~ 256 ml

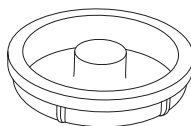

Base
external Ø mm 180
internal Ø mm 54
mm 40 h
~ 848 ml

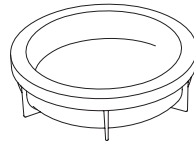

KE024
Planet
by Emmanuele Forcone

Ø mm 180×45 h
~ 1000 ml

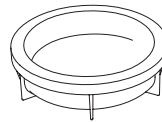

KE052
Mini Planet
by Emmanuele Forcone

Ø mm 145×40 h
~ 600 ml

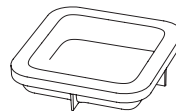

KE043
Mars
by Emmanuele Forcone

mm 165×165×40 h
~ 1000 ml

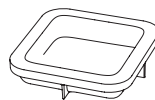

KE051
Mini Mars
by Emmanuele Forcone

mm 135×135×37 h
~ 600 ml



KE013
Plissée
by Emmanuele Forcone

Ø mm 180×47 h
~ 1000 ml

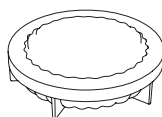

KE053
Mini Plissée
by Emmanuele Forcone

Ø mm 145×40 h
~ 550 ml

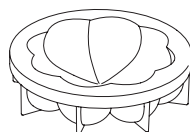

KE015
Bombée
by Emmanuele Forcone

Ø mm 180×50 h
~ 1000 ml

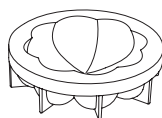

KE054
Mini Bombée
by Emmanuele Forcone

Ø mm 145×43 h
~ 550 ml

Stampi in silicone / Silicone moulds

Abbinabili con inserimento /
can be combined with insert: KE020
vedi p.131 / see p.131

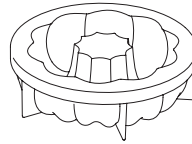

KE018
Queen
by Emmanuele Forcone

external Ø mm 180
internal Ø mm 52
mm 57 h
~ 1000 ml

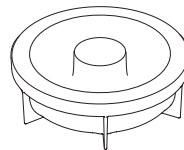

KE032
Galaxy
by Emmanuele Forcone

external Ø mm 175
internal Ø mm 55
mm 55 h
~ 1000 ml

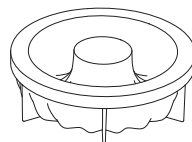

KE019
Royal
by Emmanuele Forcone

external Ø mm 180
internal Ø mm 61
mm 57 h
~ 1000 ml

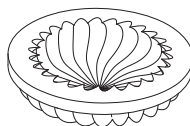

KE042
Flip
by Emmanuele Forcone

Ø mm 180×45 h
~ 900 ml

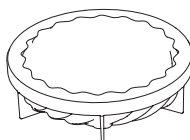

KE027
Caledon
by Emmanuele Forcone

Ø mm 180×45 h
~ 1000 ml

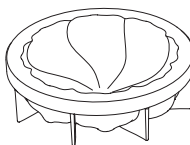

KE030
Twister
by Emmanuele Forcone

Ø mm 180×50 h
~ 1000 ml

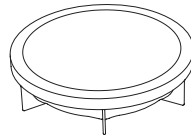

KE025
Classic
by Emmanuele Forcone

Ø mm 180×45 h
~ 1000 ml

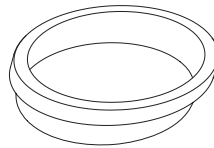

KE026
Windy
by Emmanuele Forcone

mm 195×180×45 h
~ 1100 ml

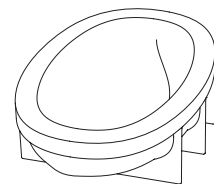

KE028
Curvy
by Emmanuele Forcone

mm 200×130×65 h
~ 960 ml

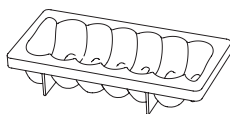

KE039
Honorè
by Emmanuele Forcone
mm 230×105×45 h
~ 1000 ml

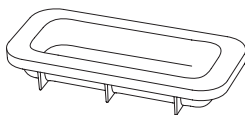

KE044
Venus
by Emmanuele Forcone
mm 250×100×40 h
~ 900 ml

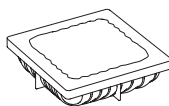

KE023
Pop
by Emmanuele Forcone
mm 162×162×46 h
~ 1000 ml

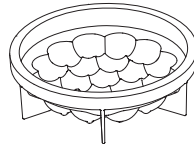

KE029
Puffy
by Emmanuele Forcone

Ø mm 180×55 h
~ 1000 ml

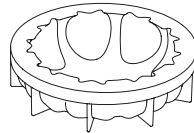

KE014
Petal
by Emmanuele Forcone

Ø mm 180×47 h
~ 1000 ml

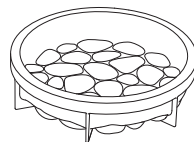

KE038
Rocky
by Emmanuele Forcone

Ø mm 180×50 h
~ 1050 ml



KE047
Nevada
 by Emmanuele Forcone

external Ø mm 180
 internal Ø mm 36
 mm 70 h
 ~ 1150 ml

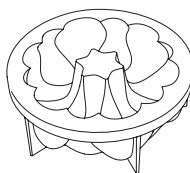

Abbinabile con
 inserimento / can be
 combined with insert:
KE020
 vedi p.131 / see p.131

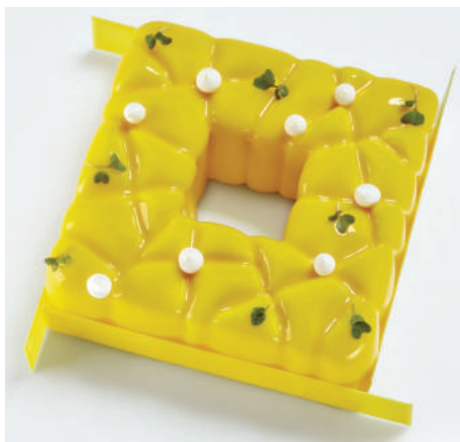

KE037
Square
 by Emmanuele Forcone

external mm 150x150
 internal mm 45x45
 55 h
 ~ 1000 ml

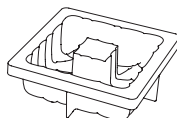

KE031
Top
 by Emmanuele Forcone

Ø mm 180x45 h
 ~ 900 ml

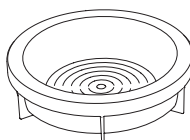

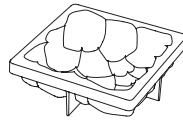

KE050
Ametista
by Emmanuele Forcone

mm 165×165×50 h
~ 1000 ml

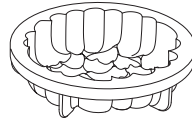

KE068
Eros
by Emmanuele Forcone

mm 179×178×48 h
~ 1022 ml

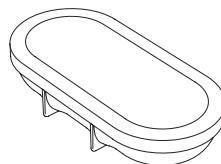

KE034
Futura
by Emmanuele Forcone

mm 230×100×45 h
~ 850 ml

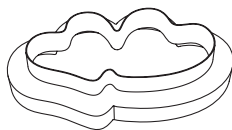

KE049S
Beloved
by Emmanuele Forcone

mm 250×140×60 h
~ 1200 ml

Coppapasta incluso /
cutter included

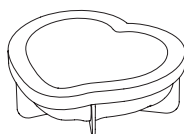
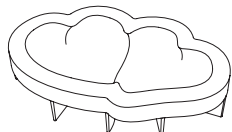

KE016
Passion
by Emmanuele Forcone

mm 175×165×58 h
~ 960 ml

Abbinabile con
inserimento / can be
combined with insert:

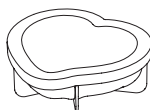

KE017
Passion
by Emmanuele Forcone

mm 150×140×50 h
~ 600 ml

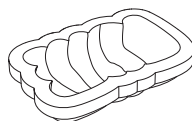

KE060
Lovely
by Antonio Bachour

mm 200×126×50 h
~ 1000 ml

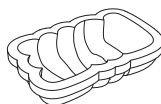

KE061
Lovely
by Antonio Bachour

mm 166×103×40 h
~550 ml

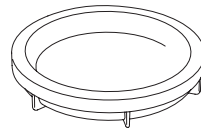

KE058
Disco
by Maurizio Santin

Ø mm 180×30 h
~ 720 ml

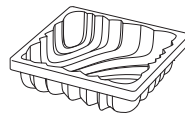

KE065
Squeeze
by Karim Bourgi

mm 164×164×47 h
~ 1086 ml



KE036
Singapore

external Ø mm 180
internal Ø mm 55
mm 60 h
~ 1000 ml

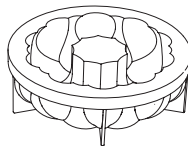

Abbinabile con
inserimento:
can be combined
with insert: KE020
vedi p.131 / see p.131



KE063
Jupiter

mm 167×158×40 h
~ 1006 ml

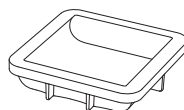

KE064
Sunny

Ø mm 180×50 h
~ 966 ml

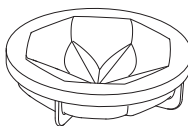

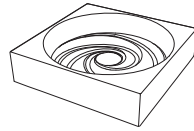

KE001

Ø mm 180×45 h
~ 900 ml

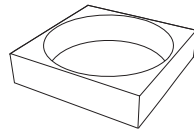

KE002

Ø mm 180×45 h
~ 1150 ml

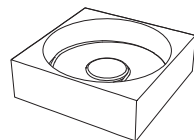

KE003

Ø mm 180×60 h
~ 1140 ml

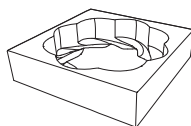

KE004

Ø mm 180×45 h
~ 920 ml

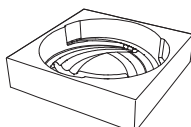

KE005

Ø mm 180×45 h
~ 1000 ml

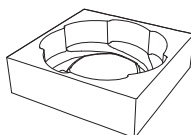

KE006

Ø mm 180×55 h
~ 1150 ml

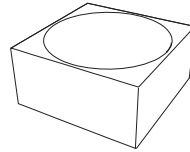

KE007

Ø mm 180×90 h
~ 1527 ml

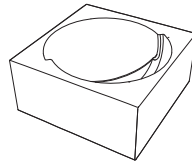

KE008

Ø mm 180×90 h
~ 1330 ml

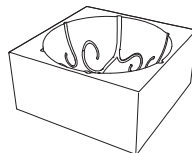

KE009

Ø mm 180×90 h
~ 1540 ml

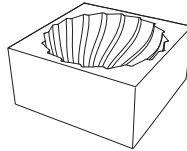

KE010

Ø mm 180×90 h
~ 1440 ml

How to use



1. Riempi lo stampo con le tue preparazioni
2. Smodella con attenzione partendo dagli angoli
3. Completa lo smodellaggio dopo aver appoggiato la torta su di una superficie piana.

1. Fill the mould with your own mixtures
2. Carefully remove the cake from the mould by the corners
3. Remove completely from the mould after placing the cake on a flat surface.

Stampi inserti per torte / Moulds for insert

Un utile aiuto per la realizzazione di inserti di
differente tipologia destinati alle tue torte.
Diversi formati, da 120 a 180 mm. /
A useful aid for creating inserts of different types
for your cakes. Various sizes, from 120 to 180 mm.

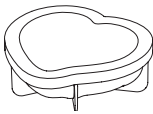

KE017

mm 150×140×50 h
~ 600 ml

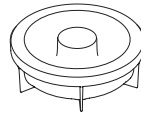

KE020

Ø est. mm 153
Ø int. mm 78
mm 44 h
~ 520 ml

Pavoflex 600×400 mm

Utilizzabili anche come stampi per torte. /
They can be used also as cake moulds.

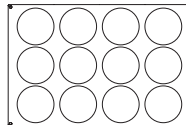

PX077

Ø mm 120×30 h
12 impronte / indents

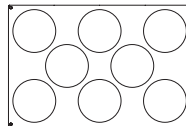

PX076

Ø mm 140×30 h
8 impronte / indents

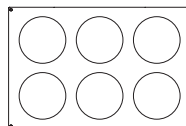

PX061

Ø mm 160×30 h
6 impronte / indents

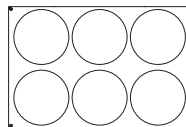

PX075

Ø mm 180×30 h
6 impronte / indents



Stampi in silicone
Silicone moulds

Stampi per tronchetti
Logs moulds

Tanti stampi per una produzione di tronchetti originale da usare per tutte le ricorrenze e di facile interpretazione.

Many moulds for an original logs production to be used for all occasions and easy to customize.

Pavocake

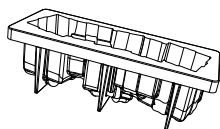

KE091
For you

mm 250×85×85 h
~ 1100 ml

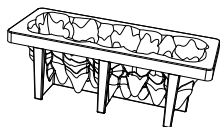
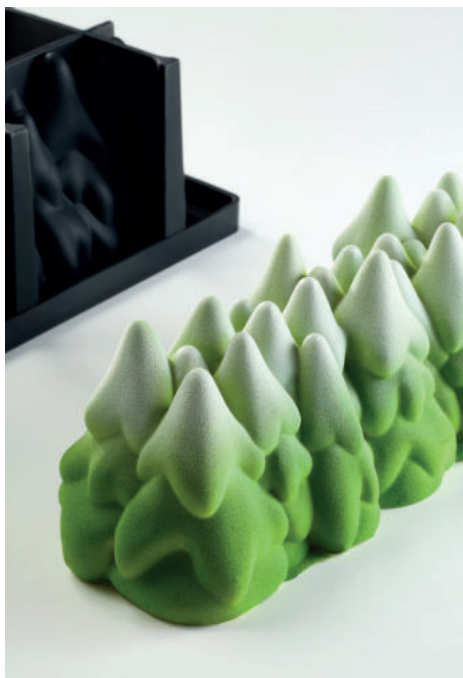

KE092
Snow tree

mm 250×90×95 h
~ 1100 ml

Stampi in silicone / Silicone moulds

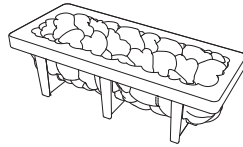

KE083
Eros

mm 250×93×74 h
~ 1250 ml

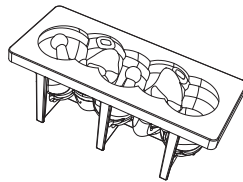

KE084
Santa log

mm 254×103×100 h
~ 1300 ml

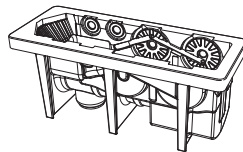

KE085
Express log

mm 250×88×106 h
~ 1435 ml

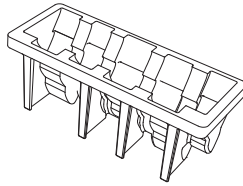

KE077
Forest

mm 250×97×95 h
~ 1065 ml

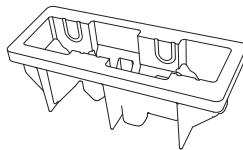

KE078
Chalet

mm 250×83×90 h
~ 1230 ml

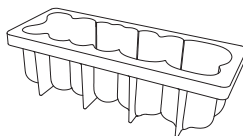

KE079
Xmas

mm 250×80×75 h
~ 1260 ml

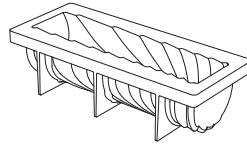

KE072
Comet

mm 250×88×73 h
~ 1230 ml

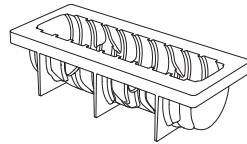

KE073
Skyline

mm 250×88×73 h
~ 1240 ml

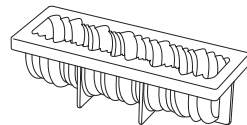

KE066
Sequoia

mm 250×92×74 h
~ 1186 ml

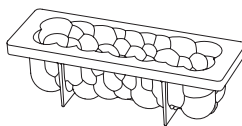
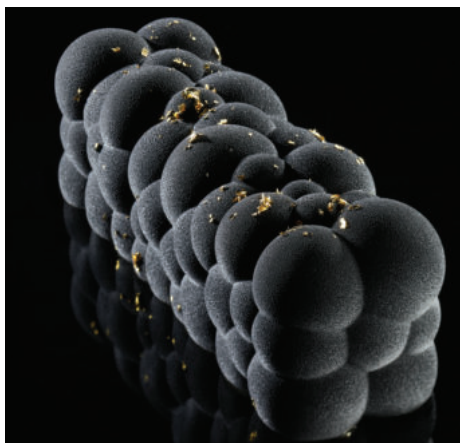

KE041
Atomic
by Emmanuele Forcone

mm 250×80×80 h
~ 1200 ml

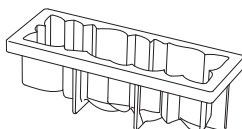

KE067
Acanto

mm 251×83×79 h
~ 1250 ml

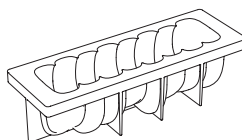

KE033
Bilbao
by Emmanuele Forcone

mm 250×85×75 h
~ 1150 ml

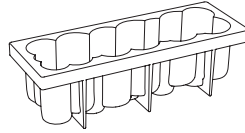

KE045
Coin
by Karim Bourgi

mm 250×80×77 h
~ 1200 ml

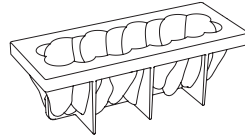

KE046
Anemone

mm 250×90×85 h
~ 1050 ml

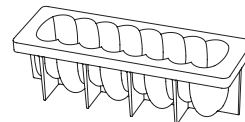

KE040
Canyon
by Emmanuele Forcone

mm 250×85×80 h
~ 1150 ml

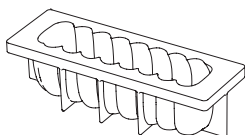

KE022
Crème
by Emmanuele Forcone
mm 250×84×75 h
~ 1000 ml

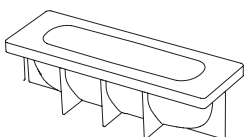

KE021
Sublime
by Emmanuele Forcone
mm 250×80×80 h
~ 1000 ml

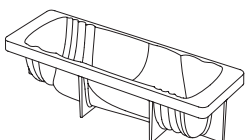

KE035
Lady
by Emmanuele Forcone
mm 250×90×75 h
~ 1150 ml

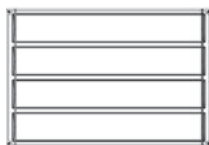

PX059
Tronchetto
mm 560×80×63 h
~ 2376 ml
4 impronte / indents

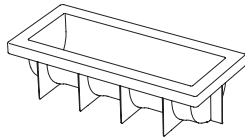

KE012
Bûche

mm 250×85×70 h
~ 1240 ml

Stampi inserto / Insert Mould

Lo stampo perfetto per creare inserti adatti a tutti i tronchetti Pavocake. /
The perfect mould for creating inserts suitable for all Pavocake logs.

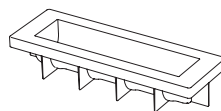
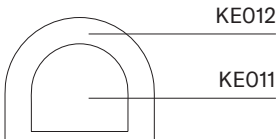

KE011

mm 230×55×50 h
~ 540 ml

Texture per tronchetti / Logs Texture

Rendi il tuo tronchetto una creazione davvero unica!
Con le texture in silicone Pavoni Italia, otterrai una
decorazione veloce e di grande effetto.

Make your log a truly unique creation! You'll get fast
and impressive decorations with these silicone mats.

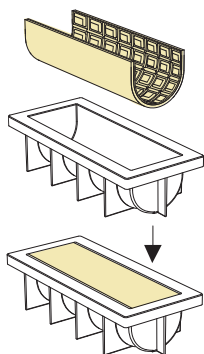

Utilizzabili con /
to be used with KE012



TX01
Cabosse

mm 250x180



TX02
Sauvage

mm 250x180

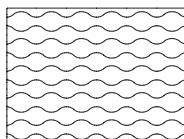
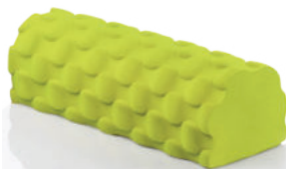

TX03
Rollé

mm 250x180

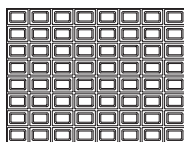

TX04
Chocolat

mm 250x180



Tronchetti Porzionabili / Portionable Logs

Pavoflex 400×300 mm

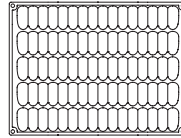

PX4320
Plummy

mm 360×50×36 h
~ 410 ml
5 impronte / indents

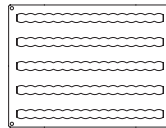

PX4310
Soft

mm 360×43×38 h
~ 360 ml
5 impronte / indents

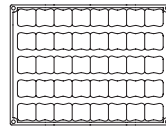
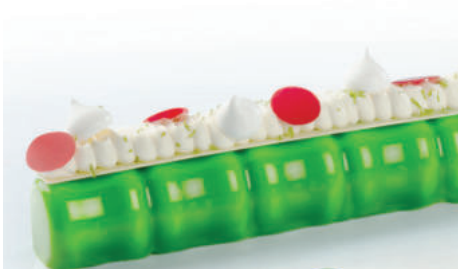

PX4318
Bamboo

mm 360×40×38 h
~ 400 ml
5 impronte / indents

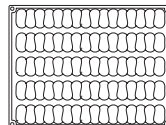

PX4319
Dada

mm 360×42×37 h
~ 420 ml
5 impronte / indents



Stampi in silicone
Silicone moulds

Stampi per top
Top moulds

Opere d'arte da appoggiare su tart, torte, monoporzioni o da proporre al piatto.

Piece of art to put on tarts, cakes, single portions or to create plated desserts.



Top

TOP24

Raven
by Stefano Laghi &
Sebastiano Caridi

dim stampo / mould
mm 190×190×23 h
Ø mm 180×17 h
~ 295 ml
1 impronta / indent

Abbinabile a fasce inox
microforate, stampi
monouso Voilà e stampo
in silicone Pavoflex
PX075 / Combined
with micro-perforated
stainless steel bands,
Voilà disposable moulds
and Pavoflex silicone
mould PX075

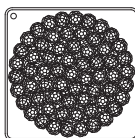

TOP20

Mini Raven
by Stefano Laghi &
Sebastiano Caridi

dim stampo / mould
mm 300×175×24 h
Ø mm 60×23 h
~ 40 ml
8 impronte / indents

Abbinabile a fasce inox
microforate, stampi
monouso Voilà VL65
e stampo in silicone
Pavoflex PX078 /
Combined with
micro-perforated
stainless steel bands,
Voilà disposable moulds
VL65 and Pavoflex
silicone mould PX078

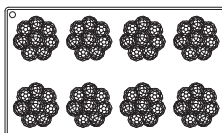



TOP27
Scarlet
by Stefano Laghi &
Sebastiano Caridi

dim stampo / mould
mm 190×190×28 h
Ø mm 180×26 h
~ 440 ml
1 impronta / indent

Abbinabile a fasce inox
microforate, stampi
monouso Voilà e stampo
in silicone Pavoflex
PX075 / Combined
with micro-perforated
stainless steel bands,
Voilà disposable moulds
and Pavoflex silicone
mould PX075

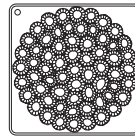

TOP23
Mini Scarlet
by Stefano Laghi &
Sebastiano Caridi

dim stampo / mould
mm 300×175×22 h
Ø mm 62×21 h
~ 38 ml
8 impronte / indents

Abbinabile a fasce inox
microforate, stampi
monouso Voilà VL65
e stampo in silicone
Pavoflex PX078 /
Combined with
micro-perforated
stainless steel bands,
Voilà disposable moulds
VL65 and Pavoflex
silicone mould PX078

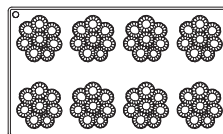

**TOP26**

Almonds
by Stefano Laghi &
Sebastiano Caridi

dim stampo / mould mm
190×190×19 h
Ø mm 180×17 h
~ 295 ml
1 impronta / indent

Abbinabile a fasce inox
microforate, stampi
monouso Voilà e stampo
in silicone Pavoflex
PX075 / Combined
with micro-perforated
stainless steel bands,
Voilà disposable moulds
and Pavoflex silicone
mould PX075

**TOP22**

Mini Almonds
by Stefano Laghi &
Sebastiano Caridi

dim stampo / mould
mm 300×175×15 h
Ø mm 60×14 h
~ 28 ml
8 impronte / indents

Abbinabile a fasce inox
microforate, stampi
monouso Voilà VL65
e stampo in silicone
Pavoflex PX078 /
Combined with
micro-perforated
stainless steel bands,
Voilà disposable moulds
VL65 and Pavoflex
silicone mould PX078

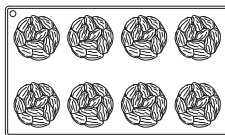



TOP25
Hazel
by Stefano Laghi &
Sebastiano Caridi

dim stampo / mould
mm 190×190×20 h
Ø mm 180×18 h
~ 267 ml
1 impronta / indent

Abbinabile a fasce inox
microforate, stampi
monouso Voilà e stampo
in silicone Pavoflex
PX075 / Combined
with micro-perforated
stainless steel bands,
Voilà disposable moulds
and Pavoflex silicone
mould PX075

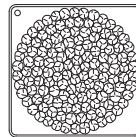

TOP21
Mini Hazel
by Stefano Laghi &
Sebastiano Caridi

dim stampo / mould mm
300×175×19 h
Ø mm 60×18 h
~ 30 ml
8 impronte / indents

Abbinabile a fasce inox
microforate, stampi
monouso Voilà VL65
e stampo in silicone
Pavoflex PX078 /
Combined with
micro-perforated
stainless steel bands,
Voilà disposable moulds
VL65 and Pavoflex
silicone mould PX078

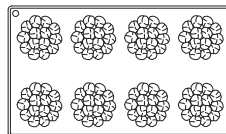



TOP07

Ipnosi
by Emmanuele Forcone

Dim stampo / mould
mm 300x175
Ø mm 60x10 h
~ 30 ml

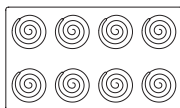

Abbinabile a / can be combined with PX078



TOP05

Ipnosi
by Emmanuele Forcone

Dim stampo / mould
mm 300x175
Ø mm 140x10 h
~ 125 ml

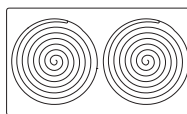

Abbinabile a fasce microforate e a KE024 / Can be combined with micro-perforated stainless steel bands and KE024



TOP06

Ipnosi
by Emmanuele Forcone

Dim stampo / mould
mm 190x190
Ø mm 160x10 h
~ 185 ml

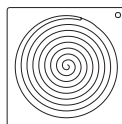

Abbinabile a fasce microforate e a KE024 / Can be combined with micro-perforated stainless steel bands and KE024



Guarda il video dedicato ai Top by Emmanuele Forcone sul canale Youtube di Pavoni Italia / Watch the video Top by Emmanuele Forcone on the Pavoni Italia's Youtube channel



TOP08
River
by Emmanuele Forcone

Dim stampo / mould mm
300x175
Ø mm 135x15 h
~ 110 ml

Abbinabile a fasce
microforate e a KE024 /
Can be combined
with micro-perforated
stainless steel bands
and KE024

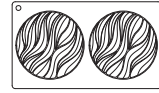

TOP11
Mini River
by Emmanuele Forcone

Dim stampo / mould mm
240x140
Ø mm 110x12 h
~ 58 ml

Abbinabile a fasce
microforate e a KE052 /
Can be combined
with micro-perforated
stainless steel bands
and KE052

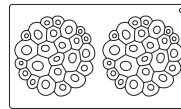

TOP09
Coral
by Emmanuele Forcone

dim stampo / mould
mm 300x175
Ø mm 135x15 h
~ 90 ml

Abbinabile a fasce
microforate e a KE024 /
Can be combined
with micro-perforated
stainless steel
bands and KE024

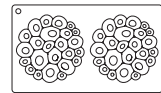

TOP10
Mini Coral
by Emmanuele Forcone

dim stampo / mould
mm 240x140
Ø mm 110x10 h
~ 45 ml

Abbinabile a fasce
microforate e a KE052 /
Can be combined
with micro-perforated
stainless steel bands
and KE052

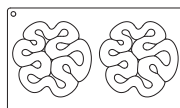

TOP15
Jelly
by Emmanuele Forcone

dim stampo / mould
mm 300×175
Ø mm 135×14 h
~ 90 ml

Abbinabile a fasce
microforate e a KE024 /
Can be combined with
micro-perforated
stainless steel bands
and KE024

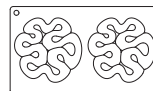

TOP16
Mini Jelly
by Emmanuele Forcone

dim stampo / mould
mm 240×140
Ø mm 110×11 h
~ 50 ml

Abbinabile a fasce
microforate e a KE052 /
can be combined with
micro-perforated
stainless steel bands
and KE052

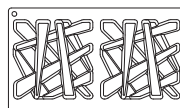

TOP13
Shanghai
by Emmanuele Forcone

dim stampo / mould
mm 300×175
mm 135×135×10 h
~ 88 ml

Abbinabile a fasce
microforate e a KE043 /
Can be combined
with micro-perforated
stainless steel bands
and KE043



TOP14
Mini Shanghai
by Emmanuele Forcone

dim stampo / mould
mm 240×140
mm 107×107×8 h
~ 45 ml

Abbinabile a fasce
microforate e a KE051 /
Can be combined
with micro-perforated
stainless steel bands
and KE051

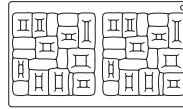

TOP01
Maya
by Emmanuele Forcone

dim stampo / mould
mm 300×175
mm 135×135×7 h
~ 90 ml

Abbinabile a fasce
microforate e a KE043 /
can be combined with
micro-perforated
stainless steel bands
and KE043

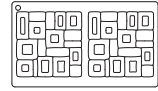

TOP12
Mini Maya
by Emmanuele Forcone

dim stampo / mould
mm 240×140
mm 107×107×7 h
~ 58 ml

Abbinabile a fasce
microforate e a KE051 /
Can be combined
with micro-perforated
stainless steel bands
and KE051

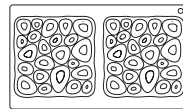

TOP02
Sponge
by Emmanuele Forcone

dim stampo / mould
mm 300×175
mm 135×135×10 h
~ 80 ml

Abbinabile a fasce
microforate e a KE043 /
Can be combined
with micro-perforated
stainless steel bands
and KE043

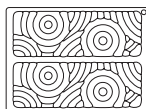

TOP04
Circle
by Emmanuele Forcone

dim stampo / mould
mm 240×175
mm 210×70×9 h
~ 90 ml

Abbinabile a fasce
microforate e a KE044 /
Can be combined
with micro-perforated
stainless steel bands
and KE044

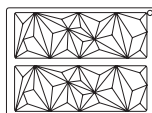

TOP03
Iceberg
by Emmanuele Forcone

dim stampo / mould
mm 240×175
mm 210×70×14 h
~ 100 ml

Abbinabile a fasce
microforate e a KE044 /
can be combined with
micro-perforated
stainless steel bands
and KE044



TOP17
Frisbee
by Gianluca Fusto

Dim stampo / mould mm
300x175
Ø mm 140x33 h
~ 285 ml

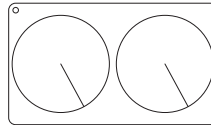

Abbinabile alla fasce
tonde microforate / can
be combined with the
micro-perforated round
bands



TOP18
Frisbee
by Gianluca Fusto

dim stampo / mould
mm 190x190
Ø mm 160x37 h
~ 414 ml

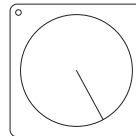

Abbinabile alla fasce
tonde microforate / can
be combined with the
micro-perforated round
bands



TOP19
Frisbee
by Gianluca Fusto

dim stampo / mould
mm 190x190
Ø mm 180x40 h
~ 572 ml

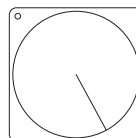

Abbinabile alla fasce
tonde microforate / can
be combined with the
micro-perforated round
bands



Stampi in silicone
Silicone moulds

Tappetini per decorazioni
Decoration mats

Stampi versatili da utilizzare con preparazioni dolci e salate, cioccolato o pasta sigaretta. Trame leggere che sapranno valorizzare ogni creazione.

Versatile moulds to be used with sweet and savory preparations, simple chocolate or “pâte à cigarette”. Light textures that will enhance every creation.

Pavodecor 300×175 mm

Leaves

Circles

Hearts

Utilizzo consigliato: decorazione per torte / Suggested use: for cake decoration

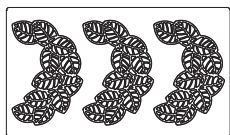

PR001

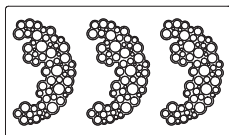

PR004

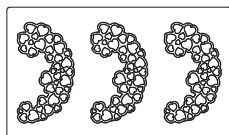

PR007

Utilizzo consigliato: decorazione per monoporzioni / Suggested use: for single portions decoration

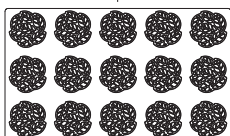

PR002

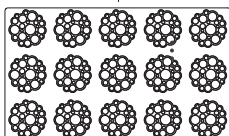

PR005

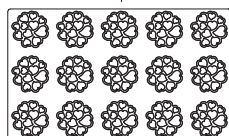

PR008

Utilizzo consigliato: decorazione per éclair / Suggested use: for éclair decoration

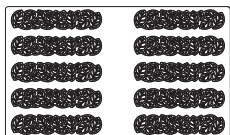

PR003

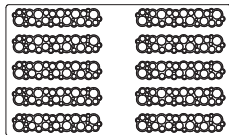

PR006

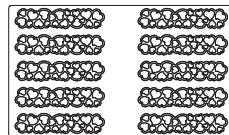

PR009



PR001
Leaves 1

mm 141×100×2 h
3 impronte / indents

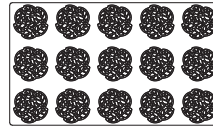
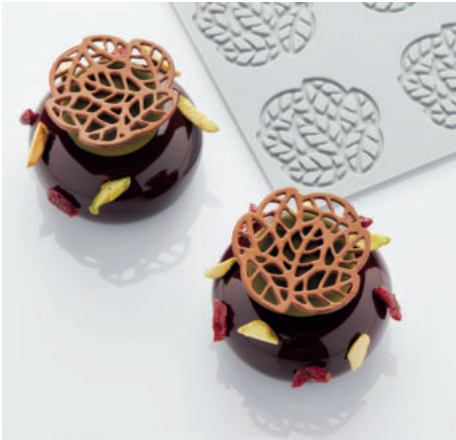

PR002
Leaves 2

Ø mm 50×2 h
15 impronte / indents

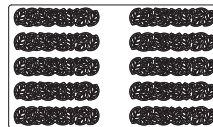

PR003
Leaves 3

mm 120×26×2 h
10 impronte / indents

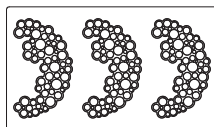

PR004
Circles 1

mm 142×84×2 h
3 impronte / indents

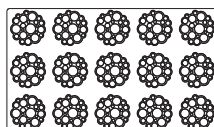

PR005
Circles 2

Ø mm 50×2 h
15 impronte / indents

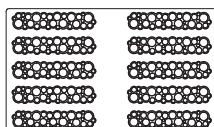

PR006
Circles 3

mm 120×25×2 h
10 impronte / indents

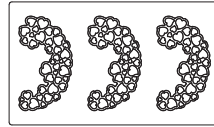

PR007
Hearts 1

mm 137×76×2 h
3 impronte / indents

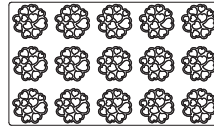

PR008
Hearts 2

Ø mm 50×2 h
15 impronte / indents

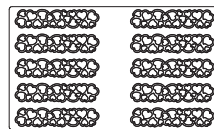

PR009
Hearts 3

mm 120×27×2 h
10 impronte / indents



Stampi in silicone
Silicone moulds

Gourmand Inspiration

Ogni creazione dolce può essere
valorizzata dai nostri stampi
Gourmand.

Every sweet creation can be
emphasised by our Gourmand
moulds.

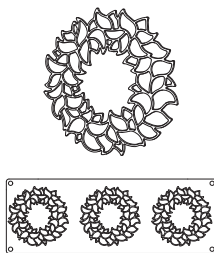

GG060
Foliage Frame
by Paolo Griffa

Ø mm 115×1,5 h
3 impronte / indents

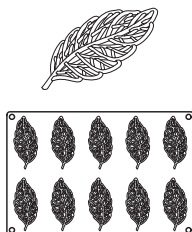

GG028
Plume
by Paolo Griffa

mm max 84×38×2 h
10 impronte / indents



GG048
Oak tree
by Paolo Griffa

mm 98×53×2 h
8 impronte / indents

Stampi in silicone / Silicone moulds

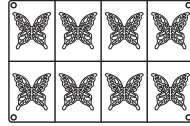

GG050
Mariposa L
by Paolo Griffa

mm 60×58×2 h
8 impronte / indents

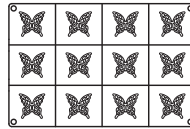

GG051
Mariposa S
by Paolo Griffa

mm 40×39×2 h
12 impronte / indents

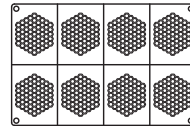
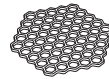

GG047
Honeycomb
by Paolo Griffa

mm 67,5×60,5×2 h
8 impronte / indents



GG024
Mandarin
by Felix Lo Basso

mm max 38×22×15 h
~ 5 ml
30 impronte / indents

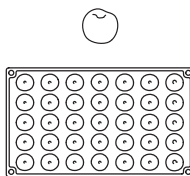

GG016
Cherry
 by Felix Lo Basso

mm max Ø 26×12 h
 ~ 8 ml
 35 impronte / indents

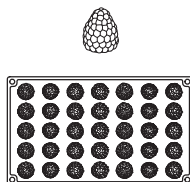

GG017
Berry
 by Felix Lo Basso

mm max Ø 24×27 h
 ~ 7 ml
 35 impronte / indents

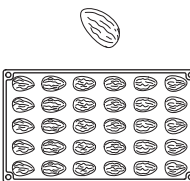

GG013
Almond
 by Felix Lo Basso

mm max 34×21×11 h
 ~ 4 ml
 30 impronte / indents

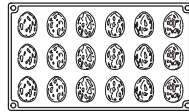

GG015
Nutshell
by Felix Lo Basso

mm max 38×28×16 h
~ 8 ml
18 impronte / indents

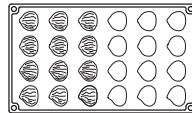

GG011
Chestnut
by Felix Lo Basso

mm max 31×27×16 h
~ 6 ml
24 impronte / indents

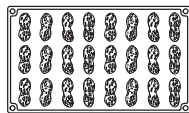

GG014
Peanut
by Felix Lo Basso

mm max 47×19×16 h
~ 7 ml
24 impronte / indents

Stampi in silicone
Silicone moulds

Formasil

Flessibili, multiuso, creativi. I tappetini microforati formasil consentono di creare prodotti da forno con un corretto sviluppo della lievitazione e forme sempre perfette.

Flexible, multipurpose and creative. The formasil micro-perforated mats allow professionals to bake goods with a perfect rise and shape.

Formasil 400×300 mm

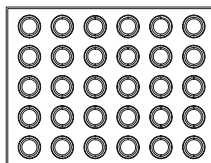

FF4306

Ø sup mm 40
Ø inf mm 32
mm 16 h
~ 16 ml

30 impronte / indents

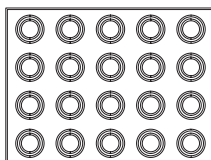

FF4301

Ø sup mm 48
Ø inf mm 36
mm 16 h
~ 22 ml

20 impronte / indents

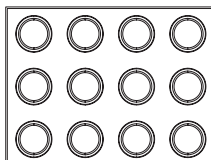

FF4308

Ø sup mm 65
Ø inf mm 55
mm 20 h
~ 57 ml

12 impronte / indents

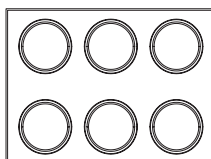

FF4311

Ø sup mm 100
Ø inf mm 90
mm 20 h
~ 140 ml

6 impronte / indents

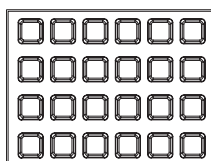

FF4303

sup dim mm 45×45
inf dim mm 37×37
mm 16 h
~ 27 ml

24 impronte / indents



Formasil 600×400 mm

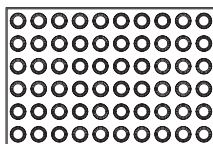

FF06

Ø sup mm 40
Ø inf mm 32
mm 16 h
~ 16 ml

60 impronte / indents

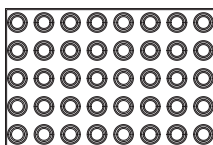

FF01

Ø sup mm 48
Ø inf mm 36
mm 16 h
~ 22 ml

40 impronte / indents

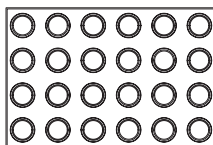

FF08

Ø sup mm 65
Ø inf mm 55
mm 20 h
~ 57 ml

24 impronte / indents

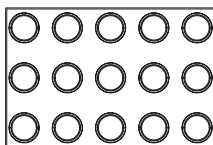

FF09

Ø sup mm 80
Ø inf mm 70
mm 20 h
~ 88 ml

15 impronte / indents

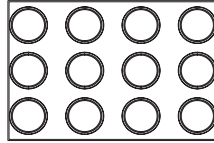

FF11

Ø sup mm 100
Ø inf mm 90
mm 20 h
~ 140 ml

12 impronte / indents

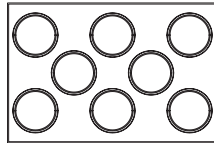

FF10

Ø sup mm 120
Ø inf mm 110
mm 30 h
~ 332 ml

8 impronte / indents

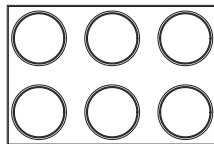

FF12

Ø sup mm 150
Ø inf mm 140
mm 30 h
~ 495 ml

6 impronte / indents

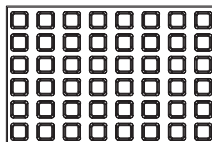

FF03

sup dim mm 45×45
 inf dim mm 37×37
 mm 16 h
 ~ 27 ml

48 impronte / indents

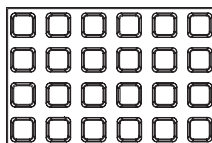

FF04

sup dim mm 65×65
 inf dim mm 55×55
 mm 20 h
 ~ 71 ml

24 impronte / indents

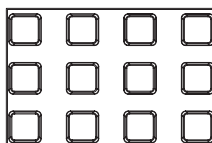

FF02

sup dim mm 85×85
 inf dim mm 75×75
 mm 20 h
 ~ 127 ml

12 impronte / indents

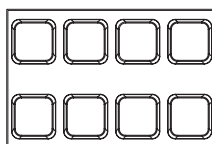

FF05

sup dim mm 120×120
 inf dim mm 106×106
 mm 30 h
 ~ 374 ml

8 impronte / indents

Formasil Éclair

Tappetini in silicone microforato e antiaderente con impronte per éclair. I microfori facilitano la distribuzione ottimale del calore e permettono all'impasto di aggrapparsi per uno sviluppo in altezza e una perfetta cottura del prodotto. Le sagome sul tappetino costituiscono un'utile guida per un utilizzo ideale. /

Micro-perforated and non-stick silicone mats with éclair indents. The micro/perforations facilitate the optimal distribution of heat and allow the dough to grip on for optimal rising and the perfect baking of the product. The outlines on the mat provide a useful guide for ideal use.

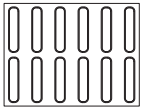

FF4313

mm 125×25×5 h
12 impronte / indents

Dim. stampo / mould
mm 400×300

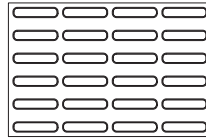

FF13

mm 125×25×5 h
24 impronte / indents

Dim. stampo / mould
mm 600×400

How to use

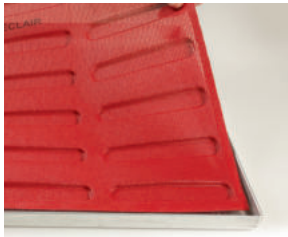

1. Appoggia il tappetino Formasil Éclair su una teglia microforata
2. Riempi le impronte con il preparato aiutandoti con un sac à poche
3. Metti in forno per una cottura e sviluppo in altezza perfetti del preparato.

1. Place the Éclair Formasil mat on a micro-perforated baking tray
2. Fill the indents with your mixture with a piping bag
3. Place in the oven for the perfect rising and baking of your creation.

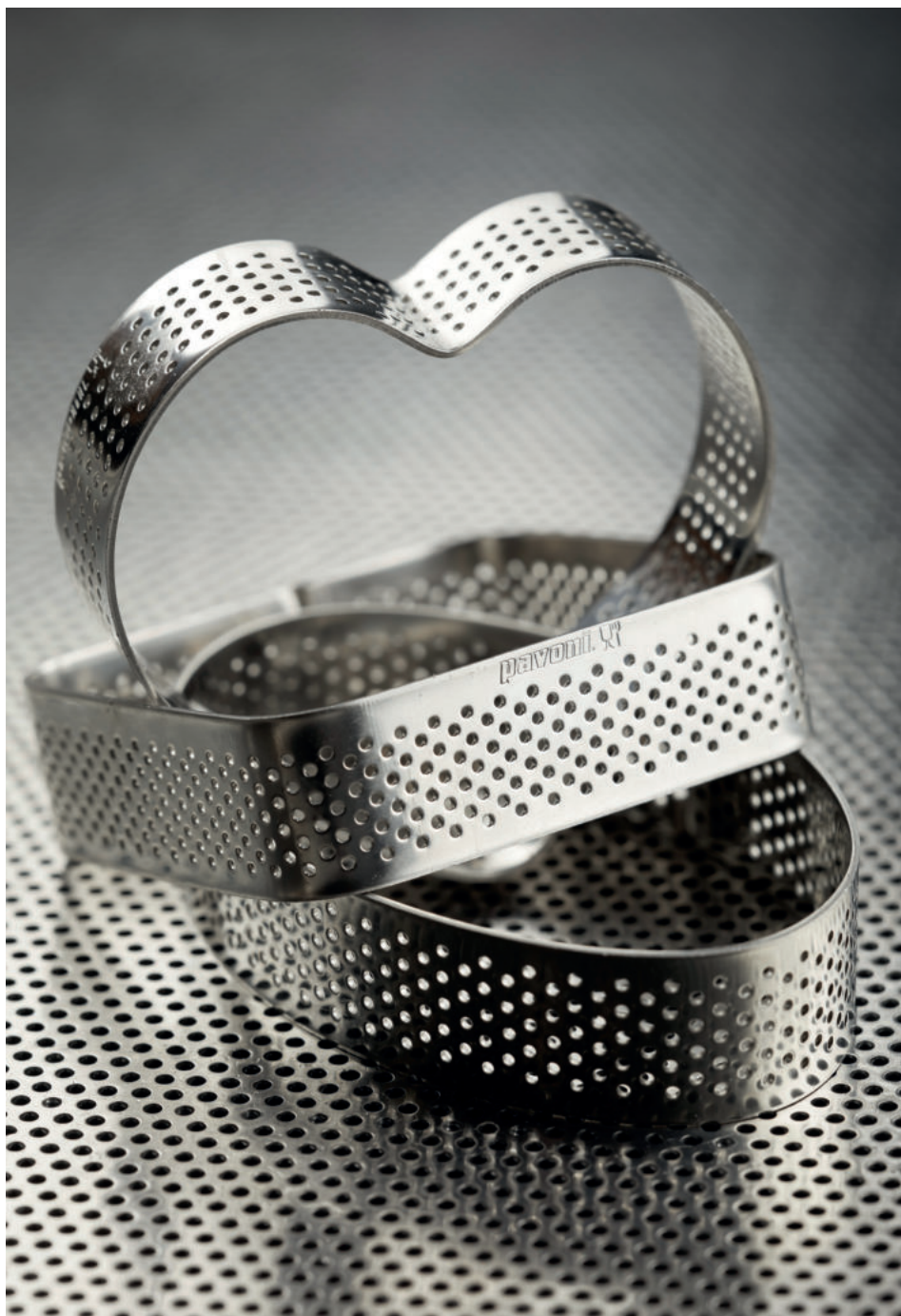

Fasce inox
Stainless steel bands

Fasce inox microforate *Micro-perforated stainless steel bands*

Stampi Inox microforati che garantiscono una cottura omogenea e sfornatura facile. Tante misure, altezze, forme e utilizzi. Fasce per crostate e fasce per lievitati e Viennoiserie.

Micro-perforated stainless steel moulds that guarantee even cooking and easy demoulding. Many sizes, heights, shapes and uses. Bands for tarts and bands for leavened products and Viennoiserie.

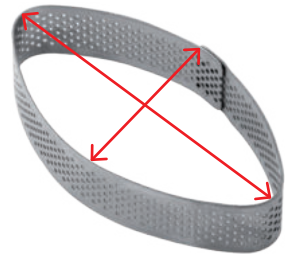

Come misurare le fasce:
Tutte le misure indicate sono interne alle fasce. /
How to measure the bands:
All measurements shown are the internal measurements of the bands.

Fasce inox microforate per crostate monoporzione / Micro-perforated stainless steel bands for single-portion tarts



XF11
mm 100×55×20 h
Abbinabile a /
combined with
PX3201 or X17



XF15
mm 125×30×20 h
Abbinabile a /
combined with
PX3204 or X21



XF12
mm 96×57×20 h
Abbinabile a /
combined with
PX3202 or X18

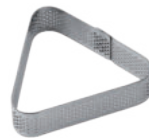

XF16
mm 85×75×20 h
Abbinabile a /
combined with
PX3205 or X22



XF13
mm 90×50×20 h
Abbinabile a /
combined with
PX3203 or X19



XF7020
Ø mm 70×20 h
Abbinabile a /
combined with
PX3200 or X0602



XF14
mm 75×70×20 h
Abbinabile a /
combined with
PX3206 or X20



XF0656520
mm 65×65×20 h
Abbinabile a /
combined with
PX3207 or X37

Tonda / Round



Code	Dimension (mm)
XF9020	Ø 90×20 h
XF1120	Ø 110×20 h
XF4020	Ø 40×20 h

Code	Dimension (mm)
XF5020	Ø 50×20 h
XF7035	Ø 70×35 h
XF9035	Ø 90×35 h

Quadrata con angoli arrotondati / Square with rounded corners



Code	Dimension (mm)
XF01	85×20×20 h
XF02	105×105×20 h

Fasce inox microforate per crostate / Micro-perforated stainless steel bands for tarts

Rotonde / Round



Code	Dimension (mm)	Portions
XF1520	Ø 150×20 h	2/4
XF1720	Ø 170×20 h	4/6
XF1920	Ø 190×20 h	6/8
XF2120	Ø 210×20 h	10/12
XF2320	Ø 230×20 h	14/16
XF2520	Ø 250×20 h	18/20
XF1535	Ø 150×35 h	2/4
XF1735	Ø 170×35 h	4/6
XF1935	Ø 190×35 h	6/8
XF2135	Ø 210×35 h	10/12
XF2335	Ø 230×35 h	14/16

A forma di cuore / Heart shaped



Code	Dimension (mm)	Portions
XF25	160×150×20 h	2/4
XF27	180×170×20 h	4/6
XF29	205×190×20 h	10/12
XF31	225×210×20 h	14/16
XF26	160×150×35 h	2/4
XF28	180×170×35 h	4/6
XF30	205×190×35 h	10/12
XF32	225×210×35 h	14/16

Triangolari / Triangular

	Code	Dimension (mm)	Portions
	XF17	175×160×20 h	2/4
	XF21	220×200×20 h	8/10
	XF18	175×160×35 h	2/4
	XF22	220×200×35 h	8/10

Ellisse / Elliptic

	Code	Dimension (mm)	Portions
	XF19	210×115×20 h	2/4
	XF23	270×150×20 h	6/8
	XF20	210×115×35 h	2/4
	XF24	270×150×35 h	6/8

Ovali / Oval

	Code	Dimension (mm)	Portions
	XFO197020	190×70×20 h	2/4
	XFO299020	220×90×20 h	8/10
	XFO197035	190×70×35 h	2/4
	XFO299035	290×90×35 h	8/10

Fasce inox microforate per crostate / Micro-perforated stainless steel bands for tarts

Quadrate / Square

angoli arrotondati / rounded corners

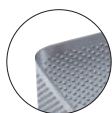

Code	Dimension (mm)	Portions
XF03	150x150x20 h	2/4
XF04	190x190x20 h	6/8
XF05	150x150x35 h	2/4
XF06	190x190x35 h	6/8

angoli vivi / sharp corners



Code	Dimension (mm)	Portions
XF151520	150x150x20 h	2/4
XF191920	190x190x20 h	6/8
XF151535	150x150x35 h	2/4
XF191935	190x190x35 h	6/8

Rettangolari / Rectangular

angoli arrotondati / rounded corners

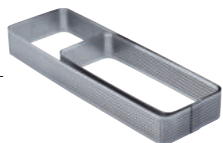
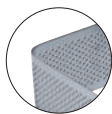

Code	Dimension (mm)	Portions
XF07	190x80x20 h	2/4
XF08	290x90x20 h	6/8
XF09	190x80x35 h	2/4
XF10	290x90x35 h	6/8

angoli vivi / sharp corners

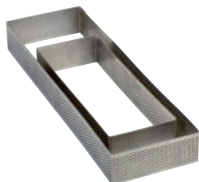

Code	Dimension (mm)	Portions
XF197020	190x80x20 h	2/4
XF299020	290x90x20 h	6/8
XF197035	190x80x35 h	2/4
XF299035	290x90x35 h	6/8



Fasce inox microforate per Viennoiserie / Micro-perforated rings for Viennoiserie

Forme classiche e contemporanee realizzate in acciaio inossidabile microforato, che garantiranno una cottura perfetta e permetteranno di sfornare con facilità il prodotto. /
Classic and contemporary shapes made of micro-perforated stainless steel, which will guarantee perfect cooking and allow to be easily un mould the product.



XF51

Ø mm 100×45 h



XF52

mm 125×74×45 h



XF53

Ø mm 90×45 h



XF54

mm 102×98×45 h



XF55

mm 109×82×45 h



XF56

mm 157×50×45 h



XF57

mm 80×80×45 h



XF59

mm 120×50×45 h



XF51
by Johan Martin

Ø mm 100×45 h



XF52
by Johan Martin

mm 125×74×45 h



XF53
by Johan Martin

Ø mm 90×45 h



XF54
by Johan Martin

mm 102×98×45 h



XF55
by Johan Martin

mm 109×82×45 h



XF56
by Johan Martin

mm 157×50×45 h



XF57
by Johan Martin

mm 80×80×45 h



XF59

mm 120×50×45 h

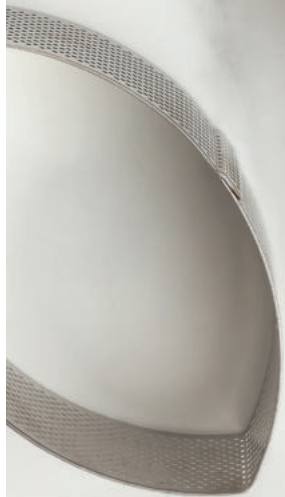



Fasce inox
Stainless steel bands

Fasce inox lisce
Smooth stainless steel bands

Fasce in acciaio inox lisce, di piccole e grandi dimensioni, per ogni utilizzo.

Smooth stainless steel bands, small and large in size, for every use.

Fasce inox lisce per monoporzione / Smooth stainless steel bands for single-serving portions



X17
mm 90×45×20 h
Abbinabile a /
combined with
XF11



X21
mm 115×20×20 h
Abbinabile a /
combined with
XF15



X18
mm 85×45×20 h
Abbinabile a /
combined with
XF12



X22
mm 75×65×20 h
Abbinabile a /
combined with
XF16



X19
mm 80×40×20 h
Abbinabile a /
combined with
XF13



X0602
Ø mm 60×20 h
Abbinabile a /
combined with
XF7020



X20
mm 65×60×20 h
Abbinabile a /
combined with
XF14



X37
mm 55×55×20 h
Abbinabile a /
combined with
XFO656520

Tonda / Round



Code	Dimension (mm)
X0802	Ø 80×20 h
X1002	Ø 100×20 h

Quadrata con angoli arrotondati / Square with rounded corners



Code	Dimension (mm)
X01	70×70×20 h
X02	90×90×20 h

Rotonde / Round



Code	Dimension (mm)	Portions
X1202	Ø 120×20 h	2/4
X1402	Ø 140×20 h	2/4
X1602	Ø 160×20 h	4/6
X1802	Ø 180×20 h	6/8
X2002	Ø 200×20 h	10/12
X2202	Ø 220×20 h	14/16
X2402	Ø 240×20 h	18/20

A forma di cuore / Heart shaped



Code	Dimension (mm)	Portions
X32	130×120×20 h	2/4
X31	150×140×20 h	4/6
X33	170×160×20 h	6/8
X34	195×180×20 h	10/12
X35	220×200×20 h	14/16

Fasce inox lisce / Smooth stainless steel bands

Triangolari / Triangular



Code	Dimension (mm)	Portions
X24	150×130×20 h	2/4
X23	170×150×20 h	2/4
X28	195×170×20 h	8/10
X27	215×190×20 h	8/10

Ellisse / Elliptic



Code	Dimension (mm)	Portions
X26	180×90×20 h	2/4
X25	205×110×20 h	2/4
X30	235×120×20 h	6/8
X29	260×140×20 h	6/8

Ovali / Oval



Code	Dimension (mm)	Portions
XO186020	180×60×20 h	2/4
XO288020	280×80×20 h	6/8

Quadrate / Square

angoli arrotondati / rounded corners



Code	Dimension (mm)	Portions
X03	120x120x20 h	2/4
X04	140x140x20 h	2/4
X05	160x160x20 h	4/6
X06	180x180x20 h	6/8

angoli vivi / sharp corners

Code	Dimension (mm)	Portions
X121220	120x120x20 h	2/4
X141420	140x140x20 h	6/8
X161620	160x160x20 h	2/4
X181820	180x180x20 h	6/8

Rettangolari / Rectangular

angoli arrotondati / rounded corners

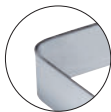

Code	Dimension (mm)	Portions
X07	180x60x20 h	2/4
X08	280x80x20 h	6/8

angoli vivi / sharp corners



Code	Dimension (mm)	Portions
X186020	180x60x20 h	2/4
X288020	280x80x20 h	6/8

Fasce inox lisce / Smooth stainless steel bands

Tonda / Round*



Code	Dimension (mm)	Spessore / Thickness
X0602	Ø 60×20 h	15/10
X0802	Ø 80×20 h	15/10
X1002	Ø 100×20 h	15/10
X1202	Ø 120×20 h	15/10
X1402	Ø 140×20 h	15/10
X1602	Ø 160×20 h	15/10
X1802	Ø 180×20 h	15/10
X2002	Ø 200×20 h	15/10
X2202	Ø 220×20 h	15/10
X2402	Ø 240×20 h	15/10
X2602	Ø 260×20 h	15/10
X2802	Ø 280×20 h	15/10
X1403	Ø 140×30 h	15/10
X1603	Ø 160×30 h	15/10
X1803	Ø 180×30 h	15/10
X3910	Ø 100×40 h	15/10
X3912	Ø 120×40 h	15/10
X3914	Ø 140×40 h	15/10
X3916	Ø 160×40 h	15/10
X3918	Ø 140×40 h	15/10
X3920	Ø 200×40 h	15/10
X3922	Ø 220×40 h	15/10
X3924	Ø 240×40 h	15/10
X3926	Ø 260×40 h	15/10
X3928	Ø 280×40 h	15/10
X3930	Ø 300×40 h	15/10
X3932	Ø 320×40 h	15/10
X3934	Ø 340×40 h	15/10
X3936	Ø 360×40 h	15/10
X4010	Ø 100×50 h	15/10

Fasce inox / Stainless steel bands

Code	Dimension (mm)	Spessore / Thickness
X4012	Ø 120×50 h	15/10
X4014	Ø 140×50 h	15/10
X4016	Ø 160×50 h	15/10
X4018	Ø 180×50 h	15/10
X4020	Ø 200×50 h	15/10
X4022	Ø 220×50 h	15/10
X4024	Ø 240×50 h	15/10
X4026	Ø 260×50 h	15/10
X4028	Ø 280×50 h	15/10
X4030	Ø 300×50 h	15/10
X4032	Ø 320×50 h	15/10
X4034	Ø 340×50 h	15/10
X4036	Ø 360×50 h	15/10

Rettangolari / Rectangular*



Code	Dimension (mm)	Portions
X411836	350×170×40 h	20/10
X413040	390×290×40 h	20/10
X414060	590×390×40 h	20/10
X421836	350×170×50 h	20/10
X423040	390×290×50 h	20/10
X424060	590×390×50 h	20/10

Cuore / Heart*



Code	Dimension (mm)	Portions
X7718	Ø 180×40 h	10/10
X7720	Ø 200×40 h	10/10
X7722	Ø 220×40 h	10/10
X7724	Ø 240×40 h	10/10
X7726	Ø 260×40 h	10/10

* A richiesta si possono realizzare misure particolari (quantità min: 20 pz) /
Special measures can be requested (min quantity 20pcs)

Gelato





Attrezzature e stampi per gelato
Gelato equipments and moulds

Stampi per stecchi gelato
Moulds for gelato sticks

Pavogel è una linea di stampi per gelati a stecco dalle forme originali, disponibile anche nei formati pocket e snack.

Pavogel is a line of moulds for gelato stick with amazing different shapes. Pavogel is also available in pocket and snack format.

Pavogel

Dimensione stampo singolo /
Single mould size 200x150 mm

Dimensione kit 4 stampi /
Kit 4 moulds size 400x300 mm

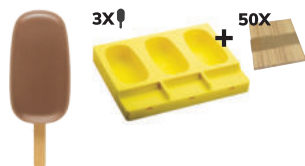

Single mould

PL13
Capri

mm 49x93 h
~ 90 ml

Stampo singolo + 50 stecchi
/Single mould + 50 sticks

3 impronte / 3 indents

Kit 4 moulds

KITPL13
Capri

Kit 4 stampi + vassoio + 50 stecchi /
Kit 4 moulds + tray + 50 sticks

12 impronte / 12 indents

16 kit per masterbox
16 kit for masterbox

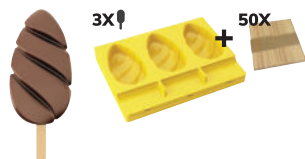

PL01
Malibù

mm 52x95 h
~ 85 ml

Stampo singolo + 50 stecchi
/Single mould + 50 sticks

3 impronte / 3 indents

KITPL01
Malibù

Kit 4 stampi+vassoio+50 stecchi /
Kit 4 moulds+tray+50 sticks

2 impronte / 12 indents

16 kit per masterbox /
16 kit for masterbox



PL02
Acapulco

mm 50x95 h
~ 90 ml

Stampo singolo+50 stecchi
Single mould+50 sticks

3 impronte / 3 indents

KITPL02
Acapulco

Kit 4 stampi+vassoio+50 stecchi /
Kit 4 moulds+tray+50 sticks

12 impronte / 12 indents

16 kit per masterbox /
16 kit for masterbox



Guarda il video dedicato a Pavogel sul canale Youtube di Pavoni Italia /
Watch the video Pavogel on the Pavoni Italia's Youtube channel



Single mould

PLO3
Maracaibo

mm 48x85 h
~ 85 ml

Stampo singolo+50 stecchi /
Single mould+50 sticks

3 impronte / 3 indents

Kit 4 moulds

KITPLO3
Maracaibo

Kit 4 stampi+vassoio+50 stecchi /
Kit 4 moulds+tray+50 sticks

12 impronte / 12 indents

16 kit per masterbox /
16 kit for masterbox

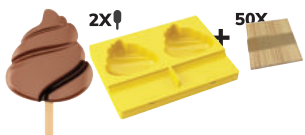

PLO4
Honolulu

mm 83x84 h
~ 100 ml

Stampo singolo+50 stecchi /
Single mould+50 sticks

2 impronte / 2 indents

KITPLO4
Honolulu

Kit 4 stampi+vassoio+50 stecchi /
Kit 4 moulds+tray+50 sticks

8 impronte / 8 indents

16 kit per masterbox / 16 kit for
masterbox

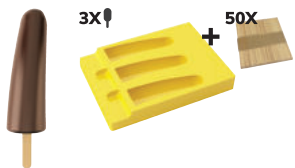

PLO5
Ipanema

mm 35x110 h
~ 70 ml

Stampo singolo+50 stecchi /
Single mould+50 sticks

3 impronte / 3 indents

KITPLO5
Ipanema

Kit 4 stampi+vassoio+50 stecchi /
Kit 4 moulds+tray+50 sticks

12 impronte / 12 indents

16 kit per masterbox / 16 kit for
masterbox

Pavogel Pocket

Dimensione stampo singolo /
Single mould size 200×120 mm

Dimensione kit 2 stampi /
Kit 2 moulds size 400×120 mm

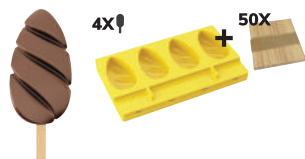

Single mould

PL06
Malibù

mm 40×72 h
~ 35 ml

Stampo singolo+50 stecchi
Single mould+50 sticks

4 impronte / 4 indents

Kit 2 moulds

KITPL06
Malibù

Kit 2 stampi+vassoio+50 stecchi
Kit 2 moulds+tray+50 sticks

8 impronte / 8 indents

12 kit per masterbox /
12 kit for masterbox

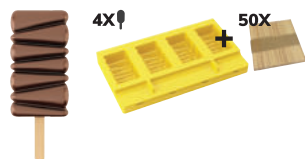

PL07
Maracaibo

mm 37×65 h
~ 35 ml

Stampo singolo+50 stecchi
Single mould+50 sticks

4 impronte / 4 indents

KITPL07
Maracaibo

Kit 2 stampi+vassoio+50 stecchi
Kit 2 moulds+tray+50 sticks

8 impronte / 8 indents

12 kit per masterbox /
12 kit for masterbox

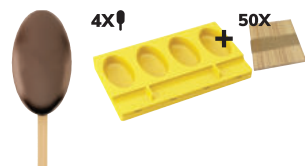

PL08
Waikiki

mm 40×70 h
~ 35 ml

Stampo singolo+50 stecchi
Single mould+50 sticks

4 impronte / 4 indents

KITPL08
Waikiki

Kit 2 stampi+vassoio+50 stecchi
Kit 2 moulds+tray+50 sticks

8 impronte / 8 indents

12 kit per masterbox /
12 kit for masterbox



PL09
Cupcake

mm 50×70 h
~ 40 ml

Stampo singolo+50 stecchi
Single mould+50 sticks

3 impronte / 3 indents

KITPL09
Cupcake

Kit 2 stampi+vassoio+50 stecchi
Kit 2 moulds+tray+50 sticks

6 impronte / 6 indents

12 kit per masterbox /
12 kit for masterbox

Pavogel Snack

Dimensione stampo singolo /
Single mould size 200x120 mm

Dimensione kit 2 stampi /
Kit 2 moulds size 400x120 mm

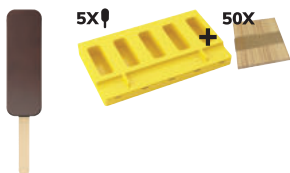

Single mould

PL10
Linear

mm 20x60 h
~ 25 ml

Stampo singolo+50 stecchi
Single mould+50 sticks

5 impronte / 5 indents

Kit 2 moulds

KITPL10
Linear

Kit 2 stampi+vassoio+50 stecchi
Kit 2 moulds+tray+50 sticks

10 impronte / 10 indents

12 kit per masterbox /
12 kit for masterbox

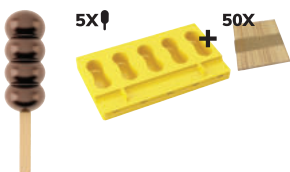

PL11
Bubbles

mm 25x60 h
~ 20 ml

Stampo singolo+50 stecchi
Single mould+50 sticks

5 impronte / 5 indents

KITPL11
Bubbles

Kit 2 stampi+vassoio+50 stecchi
Kit 2 moulds+tray+50 sticks

10 impronte / 10 indents

12 kit per masterbox /
12 kit for masterbox

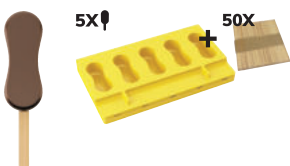

PL12
Round

mm 23x60 h
~ 20 ml

Stampo singolo+50 stecchi
Single mould+50 sticks

5 impronte / 5 indents

KITPL12
Round

Kit 2 stampi+vassoio+50 stecchi
Kit 2 moulds+tray+50 sticks

10 impronte / 10 indents

12 kit per masterbox /
12 kit for masterbox

Rainbow Stick

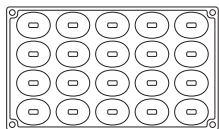

PX3212S
Rainbow stick

mm 46×35×12 h
~ 12 ml
20 impronte / indents

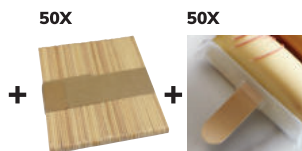

Kit stampo in silicone 300×175 mm+50 stecchi+50 fermastecchi /
Kit silicone moulds 300×175 mm+50 sticks+50 stick fasteners



Accessori per / Accessories for Pavogel & Rainbow Stick

Stecchi e fermastecchi / Sticks and stick fasteners



KS47

mm 110

Per / For
Pavogel, Rainbow Stick
Confezione da 50 stecchi /
Pack of 50 sticks



KS48

mm 75

Per / For
Pavogel, Rainbow Stick
Confezione da 50 stecchi /
Pack of 50 sticks



KSSUP

Per / for Rainbow Stick
Confezione da 50 fermastecchi /
Pack of 50 stick fasteners

Vassoi / Trays



TRAYGEL

Per / For
Pavogel
mm 400×300×10 h



TRAYGELMINI

Per / For
Pavogel
mm 400×120×10 h

Espositore / Display



PAVOGEL

Espositore in policarbonato per gelati su stecco /
Polycarbonate display for ice cream on a stick

mm 360×235
44 fori / holes

Per / for Pavogel, Pavogel Pocket, Pavogel Snack, lollipops



PAVOCOOKIE

Espositore in policarbonato / Polycarbonate display

mm 360×235



Attrezzature e stampi per gelato
Gelato equipments and moulds

Stampi per vaschette gelato *Moulds for gelato pans*

Top Ice è la linea di stampi in silicone per la decorazione delle vaschette gelato. Cinque trame diverse e due formati che impediranno sbalzi di temperatura e fastidiose patine ossidative sul vostro gelato.

Top Ice is the line of silicone moulds for decorating gelato pans. Five different textures and two sizes that will prevent temperature changes and annoying oxidative films on your gelato.

Top Ice

Gelato

Top Ice è la linea di stampi in silicone per la decorazione delle vaschette gelato. Il modo nuovo di creare una vetrina capace di catturare lo sguardo e una soluzione ideale per la conservazione: Top Ice annulla l'effetto "defrost", evitando che gelato subisca sbalzi di temperatura e impedisce la formazione della fastidiosa e antiestetica patina sul gelato, dovuta all'ossidazione. Questo significa più libertà e meno lavoro. Cinque trame diverse, tutte da interpretare in modo personale, per dare a ogni gelato l'aspetto che si merita. /

Top Ice is the line of silicone moulds for decorating gelato pans. The new, simple and quick way to create a shop window able to catch the eye: Top Ice nullifies the "defrost" effect, your gelato will not be subjected to sudden changes in temperature, but kept stable. It helps avoiding the formation of that pesky, unaesthetic coat on the top of your gelato, due to oxidation. The final result: less work, more freedom. Five different textures, all to be interpreted and decorated in a personal way, to give each ice cream the look it deserves.



Vaschetta piccola / Half pan

TOP106
Iceberg

mm 361,5×152×20 h
~ 440 ml

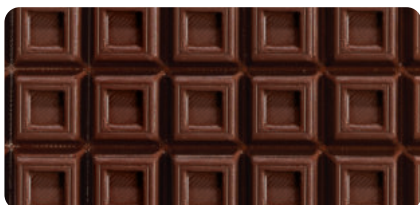

TOP107
Tablet

mm 361,5×152×18,5 h
~ 615 ml



TOP105
Coral

mm 361,5×152×21,5 h
~ 651 ml

Vaschetta intera / Whole pan

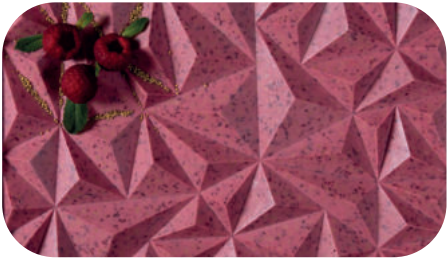

TOP100
Iceberg

mm 361,5×251,5×21 h
~ 740 ml



TOP101
Tablet

mm 361,5×251,5×18,5 h
~ 985 ml

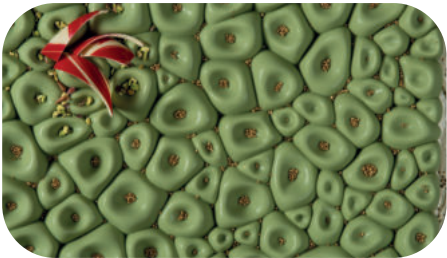

TOP102
Coral

mm 361,5×251,5×21,5 h
~ 1090 ml

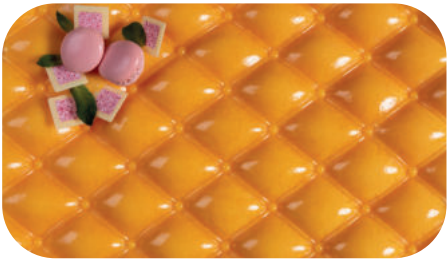

TOP103
Sofa

mm 361,5×251,5×21 h
~ 929 ml



TOP104
Dune

mm 361,5×251,5×21 h
~ 840 ml

Ristorazione
Horeca

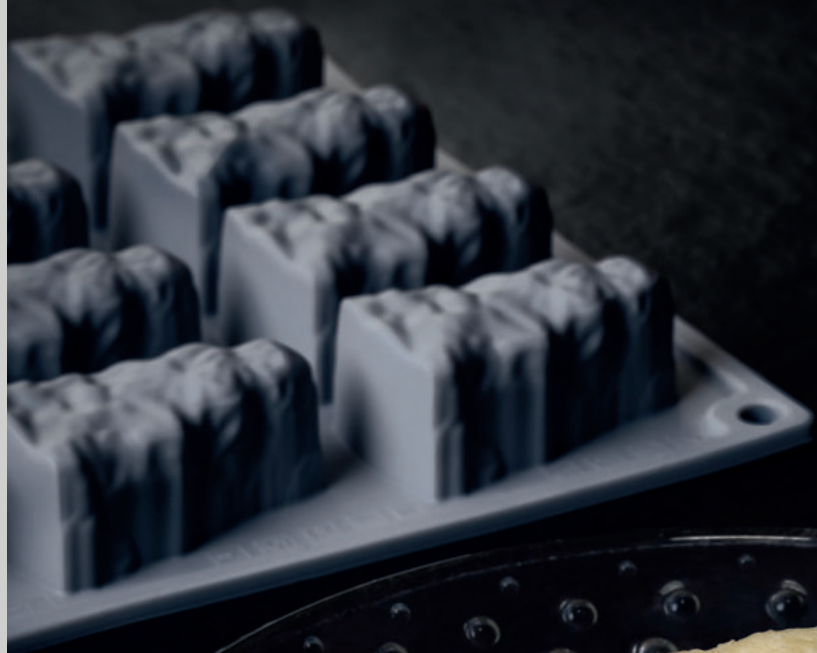



Stampi in silicone tridimensionali

Three-dimensional silicone moulds

Una gamma di stampi dalle forme tridimensionali adatta alla preparazione di appetizer, portate principali e dessert.

A range of silicone moulds suitable for the preparation of appetizers, main courses and desserts.



Foo'd 300×175 mm

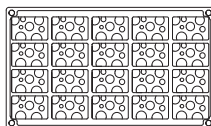

GG038
Gruyere
by Davide Oldani

mm 50×31×18 h
~ 22 ml
20 impronte / indents

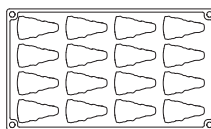

GG039
Cheese
by Davide Oldani

mm 57×30×27 h
~ 26 ml
16 impronte / indents

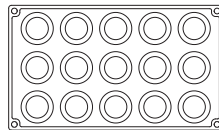

GG040
Ricotta
by Davide Oldani

Ø mm 42,5×23 h
~ 25 ml
15 impronte / indents

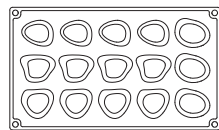

GG041
Ossobuco
by Davide Oldani

mm 48×40×23 h
~ 15 ml
15 impronte / indents

Foo'd 300×200mm

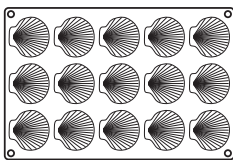
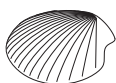

GG032
Scallop
by Davide Oldani

max mm 50×50×15
~ 14 ml
15 impronte / indents

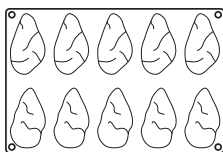

GG033
Oyster
by Davide Oldani

max mm 80×46×21
~ 20 ml
10 impronte / indents

Foo'd 400×300 mm

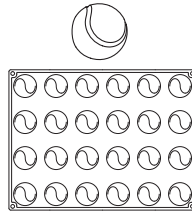

PX4338
Battuta d'inizio
by Davide Oldani

Ø mm 45
~ 48 ml
24 impronte / indents

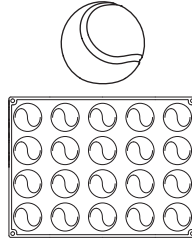

PX4327
Battuta d'inizio
by Davide Oldani

Ø mm 55
~ 80 ml
20 impronte / indents

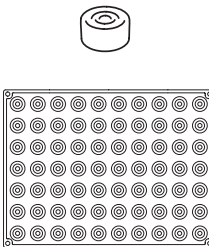

PX4328
Dama
by Davide Oldani

Ø mm 25
~ 5,5 ml
70 impronte / indents



Gourmand 300×175 mm

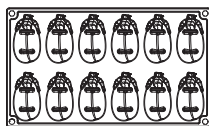

GG055
Melanzana
by Franco Aliberti

mm 67×35×25 h
~ 35 ml
12 impronte / indents

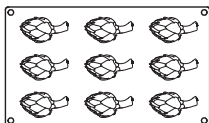

GG056
Carciofo
by Franco Aliberti

mm 74×40×30 h
~ 35 ml
9 impronte / indents

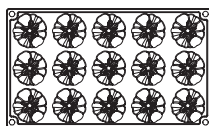

GG057
Cuore di bue
by Franco Aliberti

Ø mm 45×35 h
~ 35 ml
15 impronte / indents

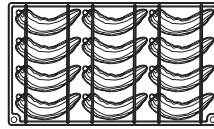

GG058
Friggitello
by Franco Aliberti

mm 90×35×20 h
~ 20 ml
12 impronte / indents

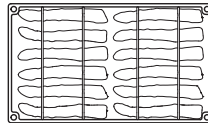
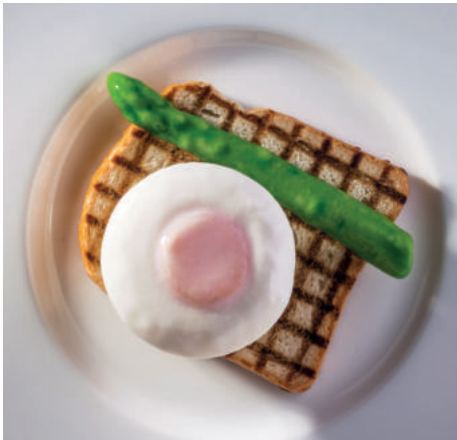

GG034
Asparagus
by Franco Aliberti

mm max 129×19×14 h
~ 15 ml
12 impronte / indents

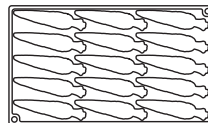

GG046
Carrot
by Franco Aliberti

mm 105,5×21×16 h
~ 15 ml
15 impronte / indents

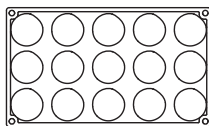

GG036
Gala (apple)

mm Ø 45×37,5 h
~ 46 ml
15 impronte / indents

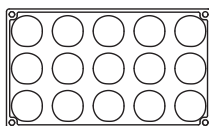

GG037
Kaiser (pear)

mm Ø 43×55 h
~ 46 ml
15 impronte / indents

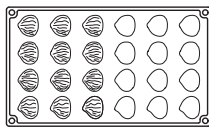

GG011
Chestnut
by Felix Lo Basso

mm max 31×27×16 h
~ 6 ml
24 impronte / indents

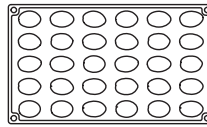

GG012
Olive
by Felix Lo Basso

mm max 32×22×18 h
~ 7 ml
30 impronte / indents

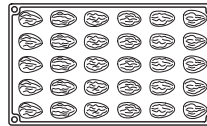

GG013
Almond
by Felix Lo Basso

mm max 34×21×11 h
~ 4 ml
30 impronte / indents

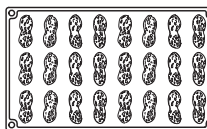

GG014
Peanut
by Felix Lo Basso

mm max 47×19×16 h
~ 7 ml
24 impronte / indents

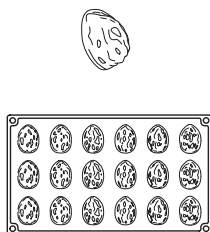

GG015
Nutshell
by Felix Lo Basso

mm max 38×28×16 h
~ 8 ml
18 impronte / indents

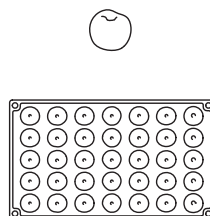

GG016
Cherry
by Felix Lo Basso

mm max Ø 26×12 h
~ 8 ml
35 impronte / indents

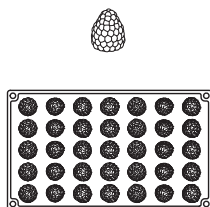

GG017
Berry
by Felix Lo Basso

mm max Ø 24×27 h
~ 7 ml
35 impronte / indents



GG024
Mandarin
by Felix Lo Basso

mm max 38×22×15 h
~ 5 ml
30 impronte / indents

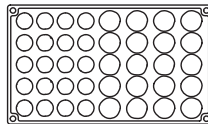

GG025
Mushroom
by Felix Lo Basso

mm max 28×29×27 h
(fungo completo /
whole mushroom)
~ 8 ml
20 impronte / indents
(fungo completo /
whole mushroom)

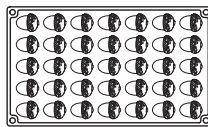

GG026
Nut
by Felix Lo Basso

mm max 31×23×19 h
~ 6 ml
35 impronte / indents

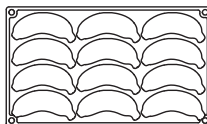

GG035
Baby banana
by Eunji Lee

mm 90×40,5×25 h
~ 40 ml
12 impronte / indents

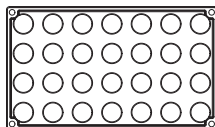

GG053
Pop

Ø mm 24×23 h
~ 7 ml
28 impronte / indents

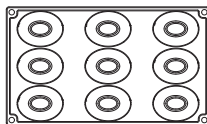

GG054
Egg
by Andrea Berton

mm 63×48×40 h
~ 72 ml
9 impronte / indents

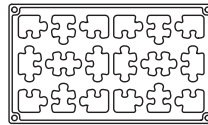

GG018
Puzzle
by Felix Lo Basso

mm 90×90×4 h (9 pcs)
~ 31 ml (9 pcs)
18 impronte / indents

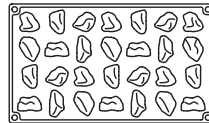

GG022
Gravel
by Felix Lo Basso

mm max 39×29×18 h
~ 6 ml
28 impronte / indents

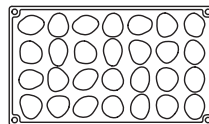

GG019
Stones
by Felix Lo Basso

mm max 36×28×15 h
~ 6 ml
28 impronte / indents

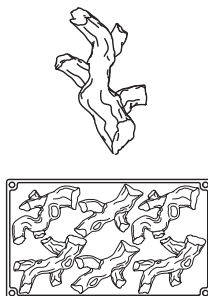

GG023
Tree
by Felix Lo Basso

mm max 120×69×18 h
~ 32 ml
6 impronte / indents

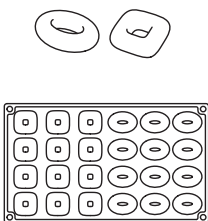

GG020
Ovosquare
by Felix Lo Basso

oval
mm 40×28×10 h
square
mm 31×31×10 h
~ 10 ml
24 impronte / indents

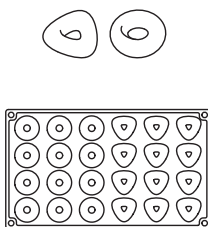

GG021
Triarround
by Felix Lo Basso

triangle
mm 33×32×10 h
round
mm Ø 34×9 h
~ 6 ml
24 impronte / indents

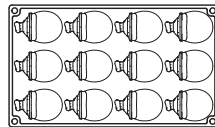
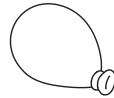

GG052
Balloon

by **Fabrizio Fiorani**

mm 66×43×34 h

~ 47 ml

12 impronte / indents



Gourmand 400×300 mm

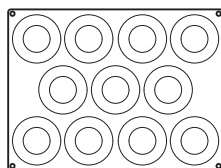

GG001
Anello piccolo
Small ring
by Paolo Griffa

mm Ø 90×3,5 h
~ 15 ml
11 impronte / indents

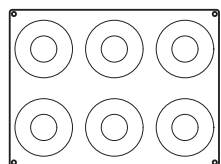

GG002
Anello grande
Ring
by Paolo Griffa

mm Ø 110×3,5 h
~ 26 ml
6 impronte / indents

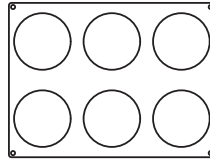

GG003
Disco grande
Disc
by Paolo Griffa

mm Ø 110×3,5 h
~ 33 ml
6 impronte / indents

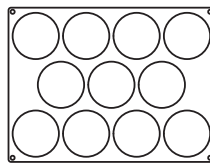

GG004
Disco piccolo
Small disc
by Paolo Griffa

mm Ø 90×3,5 h
~ 22 ml
11 impronte / indents

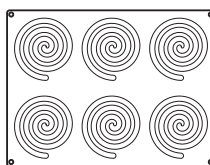

GG005
Spirale
Spiral
by Paolo Griffa

mm 120×110×3,5 h
~ 15 ml
6 impronte / indents

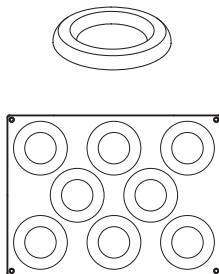

GG006
Tondo
Round
by Paolo Griffa

mm Ø 100×10 h
~ 50 ml
8 impronte / indents

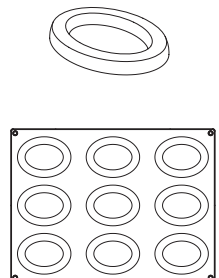

GG007
Ovale
Oval
by Paolo Griffa

mm 105×80×10 h
~ 33 ml
9 impronte / indents

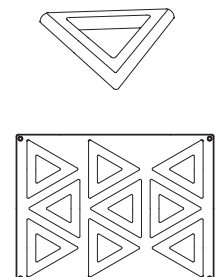

GG008
Triangolo
Triangle
by Paolo Griffa

mm 120×10×10 h
~ 40 ml
9 impronte / indents

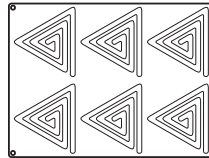
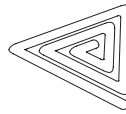

GG009
Spirale triangolo
Triangular spiral
by Paolo Griffa

mm 135×120×5 h
~ 25 ml
6 impronte / indents

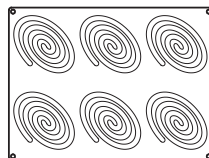

GG010
Spirale ovale
Oval spiral
by Paolo Griffa

mm 138×95×6 h
~ 28 ml
6 impronte / indents



Tappetini in silicone per decorazioni

Silicone mats for decorations

Un'esperienza che unisce forma e gusto, utilizzando design dalle trame leggere e sorprendenti.

An amazing experience combining shape and taste, using light and surprising designs.



Gourmand 395×140 mm



GG059
Mosaic Frame
by Paolo Griffa



Ø mm 115×1,5 h
3 impronte / indents

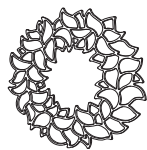

GG060
Foliage Frame
by Paolo Griffa

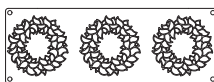

Ø mm 115×1,5 h
3 impronte / indents



GG061
Jasmine Frame
by Paolo Griffa

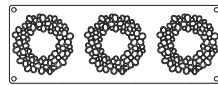

Ø mm 115×1,5 h
3 impronte / indents



GG062
Blade Frame
by Paolo Griffa

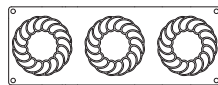

Ø mm 110×1,5 h
3 impronte / indents

Gourmand 300×200 mm

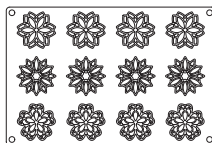

GG063
Mandala
by Paolo Griffa

Ø mm 55×2 h
12 impronte / indents



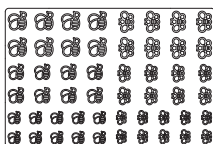
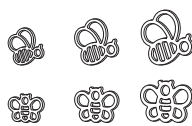

GG064
Honey Bees
by Paolo Griffa

Ø mm 20×1,5
Ø mm 25×1,5
Ø mm 30×1,5
52 impronte / indents

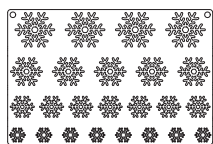

GG065
Snowflake
by Paolo Griffa

Ø mm 23×1,5
Ø mm 35×1,5
Ø mm 46×1,5
Ø mm 57×1,5
24 impronte / indents

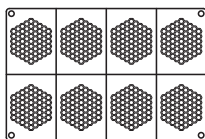
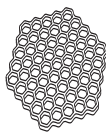

GG047
Honeycomb
by Paolo Griffa

mm 67,5×60,5×2 h
8 impronte / indents

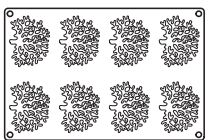

GG027
Coral
by Paolo Griffa

mm max 75×59×2 h
8 impronte / indents

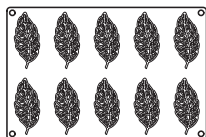

GG028
Plume
by Paolo Griffa

mm max 84×38×2 h
10 impronte / indents

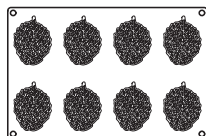

GG029
Leaf
by Paolo Griffa

mm max 73×55×2 h
8 impronte / indents

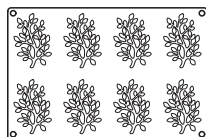

GG030
Bonsai
by Paolo Griffa

mm max 80×55×2 h
8 impronte / indents



GG031
Wood
by Paolo Griffa

mm max 78×48×2 h
10 impronte / indents

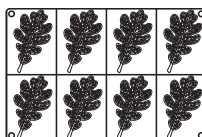

GG048
Oak tree
by Paolo Griffa

mm 98×53×2 h
8 impronte / indents

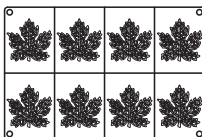

GG049
Maple
by Paolo Griffa

mm 66×62,5×2 h
8 impronte / indents

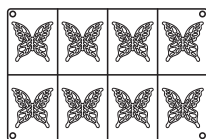

GG050
Mariposa L
by Paolo Griffa

mm 60×58×2 hl
8 impronte / indents

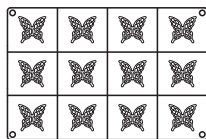

GG051
Mariposa S
by Paolo Griffa

mm 40×39×2 h
12 impronte / indents

Ciocolateria
Chocolate world



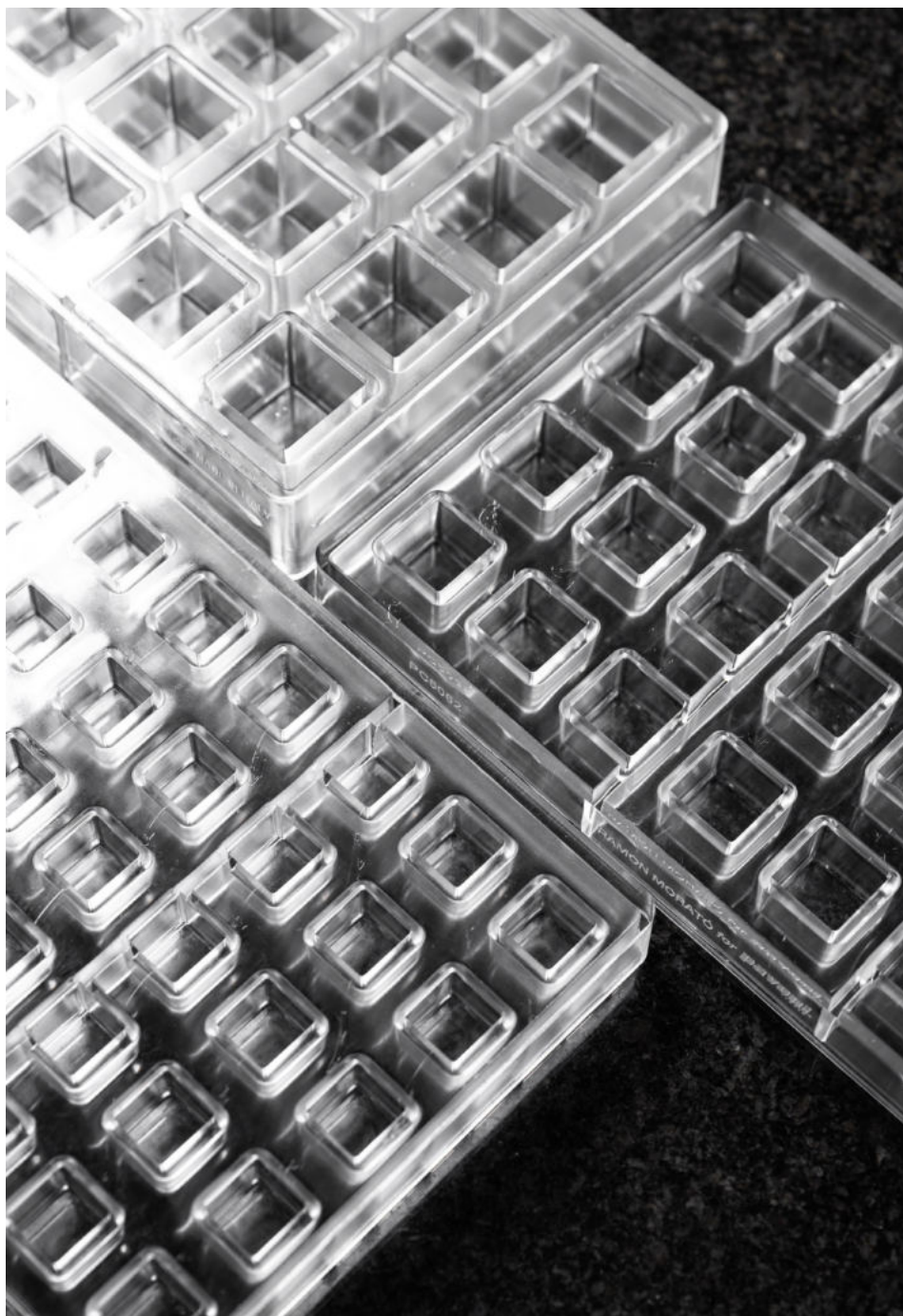

Stampi per praline

Praline moulds

Stampi in tritan ideali per un uso professionale ed intensivo, BPA free, presentano un'elevata resistenza agli urti, graffi e ai cicli di lavaggio.

Moulds in tritan ideal for professional and intensive use, BPA free, have high resistance to impacts, scratches and washing cycles.

Murano by Davide Comaschi

Stampi per praline 275×175 mm

Stampi adatti alle macchine One Shot /
Suitable for One Shot machines

24 impronte per stampo /
24 indents per mould
BPA free



PC5040

mm 41×29×13 h
+/- 10 g



PC5041

mm 36×20×18 h
+/- 10 g



PC5042

mm 40×24×14 h
+/- 10 g



PC5043

mm 31×31×13 h
+/- 10 g



PC5044

mm 43×20×13 h
+/- 10 g



PC5045

mm 41×28×14 h
+/- 10 g



PC5046

Ø mm 33×13 h
+/- 10 g



PC5047

mm 34×33×14 h
+/- 10 g



Semisfere Hemisphere

Stampi per praline 275×175 mm

Stampi adatti alle macchine One Shot /
Suitable for One Shot machines

BPA free

PC5015



Ø mm 20×10 h
+/- 2,5 g
45 impronte per stampo
45 indents per mould

PC5016



Ø mm 25×12,5 h
+/- 4 g
28 impronte per stampo
28 indents per mould

PC5017



Ø mm 30×15 h
+/- 7 g
24 impronte per stampo
24 indents per mould

PC5018



Ø mm 35×17,5 h
+/- 11 g
24 impronte per stampo
24 indents per mould

PC5019



Ø mm 40×20 h
+/- 17 g
15 impronte per stampo
15 indents per mould

PC5020



Ø mm 45×22,5 h
+/- 24 g
15 impronte per stampo
15 indents per mould

PC5021



Ø mm 50×25 h
+/- 33 g
12 impronte per stampo
12 indents per mould

PC5022



Ø mm 55×27,5 h
+/- 43 g
8 impronte per stampo
8 indents per mould

PC5023



Ø mm 60×30 h
+/- 56,5 g
8 impronte per stampo
8 indents per mould

PC5024



Ø mm 65×32,5 h
+/- 72 g
6 impronte per stampo
6 indents per mould

Artisanal

Stampi per praline 275×135 mm

21 impronte per stampo /
21 indents per mould
BPA free

Tonde / Round



PC100

Ø mm 29×14 h
+/- 10 g



PC101

Ø mm 29×14 h
+/- 10 g



PC102

Ø mm 29×14 h
+/- 10 g



PC113

Ø mm 29×14 h
+/- 10 g

Rettangolari / Rectangular



PC106

mm 37×16×14 h
+/- 10 g



PC107

mm 37×16×14 h
+/- 10 g



PC108

mm 37×16×14 h
+/- 10 g



PC114

mm 37×16×14 h
+/- 10 g

Ovali / Oval



PC109

mm 37×21×14 h
+/- 10 g



PC110

mm 37×21×14 h
+/- 10 g



PC111

mm 37×21×14 h
+/- 10 g



PC115

mm 37×21×14 h
+/- 10 g

Quadrate / Square



PC103

mm 26×26×13 h
+/- 10 g



PC104

mm 26×26×13 h
+/- 10 g



PC105

mm 26×26×13 h
+/- 10 g



PC112

mm 26×26×13 h
+/- 10 g

Artisanal

20 impronte per stampo /
20 indents per mould
BPA free

Stampo per praline 275×175 mm

Stampi adatti alle macchine One Shot /
Suitable for One Shot machines



PC5033

mm 26×26×14 h
+/- 10 g

Tradition

24 impronte per stampo /
24 indents per mould
BPA free

Stampi per praline 275×175 mm

Stampi adatti alle macchine One Shot /
Suitable for One Shot machines



PC5027

Ø mm 25×14 h
+/- 7 g



PC5026

mm 25×28×16 h
+/- 7 g

Innovation

Stampi per praline 275×135 mm

BPA free



PC36

Ø mm 25×25 h
+/- 10 g
21 impronte per stampo
21 indents per mould



PC23

by Davide Comaschi

mm 18×18×20 h
+/- 10 g
21 impronte per stampo
21 indents per mould



PC01

mm 14×37×19 h
+/- 10 g
21 impronte per stampo
21 indents per mould



PC02

mm 17×37×17 h
+/- 10 g
21 impronte per stampo
21 indents per mould



PC03

mm 15×37×15 h
+/- 10 g
21 impronte per stampo
21 indents per mould



PC04

mm 15×37×19 h
+/- 10 g
21 impronte per stampo
21 indents per mould



PC05

mm 17×37×17 h
+/- 10 g
21 impronte per stampo
21 indents per mould



PC06

mm 16×37×16 h
+/- 10 g
21 impronte per stampo
21 indents per mould



PC07

mm 17×37×17 h
+/- 10 g
21 impronte per stampo
21 indents per mould



PC08

Ø mm 30×18 h
+/- 10 g
21 impronte per stampo
21 indents per mould



PC09

Ø mm 30×18 h
+/- 10 g
21 impronte per stampo
21 indents per mould



PC10

mm 32×23×19 h
+/- 10 g
21 impronte per stampo
21 indents per mould

**PC11**

Ø mm 30×17 h
 +/- 10 g
 21 impronte per stampo
 21 indents per mould

**PC12**

mm 30×30×18 h
 +/- 10 g
 21 impronte per stampo
 21 indents per mould

**PC13**

mm 22×22×20 h
 +/- 10 g
 21 impronte per stampo
 21 indents per mould

**PC14**

Ø mm 26×16 h
 +/- 10 g
 21 impronte per stampo
 21 indents per mould

**PC15**

mm 26×23×21 h
 +/- 10 g
 21 impronte per stampo
 21 indents per mould

**PC16**

Ø mm 31×20 h
 +/- 10 g
 21 impronte per stampo
 21 indents per mould

**PC17**

mm 30×30×17 h
 +/- 10 g
 21 impronte per stampo
 21 indents per mould

**PC18**

Ø mm 28×17 h
 +/- 10 g
 21 impronte per stampo
 21 indents per mould

**PC19**

mm 22×18×28 h
 +/- 10 g
 24 impronte per stampo
 24 indents per mould

**PC20**

mm 22×21×28 h
 +/- 10 g
 24 impronte per stampo
 24 indents per mould

**PC21**

mm 18×18×28 h
 +/- 10 g
 24 impronte per stampo
 24 indents per mould

**PC22**

Ø mm 21×28 h
 +/- 10 g
 24 impronte per stampo
 24 indents per mould

**PC37**

Ø mm 26×23,5 h
 +/- 10 g
 21 impronte per stampo
 21 indents per mould

Magnetic

15 impronte per stampo /
15 indents per mould
BPA free



MM11

Ø mm 30
+/- 13 g

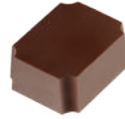

MM12

mm 35x30
+/- 15 g



MM13

mm 30x30
+/- 13 g



MM14

Ø mm 30
+/- 10 g

Heart Design by Davide Comaschi

15 impronte per stampo /
15 indents per mould
BPA free

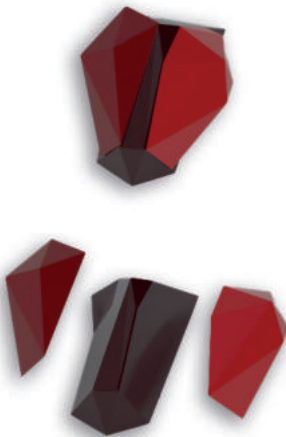

Stampi per praline 275x135 mm

3 forme diverse in ogni stampo,
per formare 5 cuori completi /
3 different shapes per mould
to create 5 whole hearts

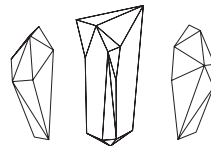

PC50

+/- 13 g

Bonbons by Antonio Bachour

Stampi per praline 275×135 mm

21 impronte per stampo /
21 indents per mould
BPA free



PC39

mm 38×26×18 h
+/- 10 g



PC41

mm 43×25×17 h
+/- 10 g



PC43

mm 36×25×20 h
+/- 10 g



PC45

Ø mm 30×16 h
+/- 10 g



PC47

mm 27×27×15 h
+/- 10 g



PC38

mm 44×24×20 h
+/- 10 g



PC40

mm 33×28×20 h
+/- 10 g



PC42

mm 41×24×20 h
+/- 10 g



PC44

mm 35×24×17 h
+/- 10 g



PC46

mm 40×18×16 h
+/- 10 g



PC48

mm 42×21×18 h
+/- 10 g

Stampi per praline / Praline moulds



PC56

mm 31×26×16 h
+/- 10 g



PC57

mm 33×26×16 h
+/- 10 g



PC58

mm 33×29×17 h
+/- 10 g



PC59

mm 26×26×16 h
+/- 10 g



PC60

mm 33×22×16 h
+/- 10 g



PC61

mm 33×27×17 h
+/- 10 g



PC62

mm 34×22×16 h
+/- 10 g



PC63

mm 30×29×17 h
+/- 10 g



PC64

mm 26×26×16 h
+/- 10 g



PC65

mm 28×28×18 h
+/- 10 g



Guarda il video dedicato sul canale Youtube di Pavoni Italia
Watch the video on Pavoni Italia's Youtube channel

Iconic by Fabrizio Fiorani

Stampi per praline 275×135 mm

21 impronte per stampo /
21 indents per mould
BPA free



PC49

mm 33×30×15 h
+/- 10 g

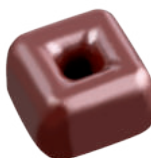

PC51

mm 26×26×16 h
+/- 10 g



PC52

mm 31×29×16 h
+/- 10 g



PC53

Ø mm 28×16 h
+/- 10 g



PC55

mm 29×30×16 h
+/- 10 g



Guarda il video dedicato sul canale Youtube di Pavoni Italia
Watch the video on Pavoni Italia's Youtube channel

Abyss by Davide Comaschi

Stampi per praline 275×135 mm

18 impronte per stampo /
18 indents per mould
BPA free



PC66

mm 31×31×12,5 h
+/- 10 g

designed by
Giuseppe Tortato
ADI DESIGN INDEX 2019



PC67

Ø mm 33×12,5 h
+/- 10 g



PC68

mm 41×24×12,5 h
+/- 10 g



PC69

mm 39×20×12,5 h
+/- 10 g



Guarda il video dedicato sul canale Youtube di Pavoni Italia
Watch the video on Pavoni Italia's Youtube channel



Stampi per tavolette

Choco bar moulds

Scopri come creare originali tavolette
in cioccolato per ogni occasione.
Stampi in tritan BPA free.

Find out how to create original
chocolate bars for every occasion.
BPA free tritan molds.



PC5051
Maxi choco
by Davide Comaschi



mm 250×150×20 h
~ 600 g
1 impronta / indent
Dim stampo / Mould
size: mm 275×175
BPA free



KS51
Confezione per tavoletta maxi
Maxi Choco bar pack

vedi pag 385 / see page 385



Guarda i video sul canale Youtube di Pavoni Italia
Watch the videos on Pavoni Italia's Youtube channel



PC5048
Easter Bunny
by Fabrizio Fiorani

mm 154×72×13 h
~ 100 g
3 impronte / indents
Dim stampo / Mould
size: mm 275×175
BPA free



PC5049
Easter Friends
by Fabrizio Fiorani

mm 154×72×15 h
~ 100 g
3 impronte / indents
Dim stampo / Mould
size: mm 275×175
BPA free



PC5060
Halloween friends
by Fabrizio Fiorani

mm 154×77×15 h
~ 100 g
3 impronte / indents
Dim stampo / Mould
size: mm 275×175
BPA free





PC5058
Xmas spirit
by Fabrizio Fiorani

mm 154×77×15 h
~ 100 g
3 impronte / indents
Dim stampo / Mould
size: mm 275×175
BPA free



PC5059
Xmas night
by Fabrizio Fiorani

mm 154×77×15 h
~ 100 g
3 impronte / indents
Dim stampo / Mould
size: mm 275×175
BPA free

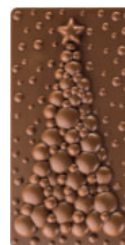

PC5037
Bubble Tree
by Fabrizio Fiorani

mm 154×77×13 h
~ 100 g
3 impronte / indents
Dim stampo / Mould
size: mm 275×175
BPA free



PC5038
Xmas Village
by Fabrizio Fiorani

mm 154×77×10 h
~ 100 g
3 impronte / indents
Dim stampo / Mould
size: mm 275×175
BPA free



PC5039
Xmas Friends
by Fabrizio Fiorani

mm 154×77×13 h
~ 100 g
3 impronte / indents
Dim stampo / Mould
size: mm 275×175
BPA free



PC5001
Sparkling
by Fabrizio Fiorani

mm 150×77×12 h
~ 100 g
3 impronte / indents
Dim stampo / Mould
size: mm 275×175
BPA free





PC5000
Lovely
by Antonio Bachour

mm 150×76×10 h
~ 100 g
3 impronte / indents
Dim stampo / Mould
size: mm 275×175
BPA free



PC5028
Eros

mm 154×77×11 h
~ 100 g
3 impronte / indents
Dim stampo / Mould
size: mm 275×175
BPA free



PC5011
Camouflage
by Fabrizio Fiorani

mm 154×77×8 h
~ 100 g
3 impronte / indents
Dim stampo / Mould
size: mm 275×175
BPA free



PC5013
Mini Bricks
by Fabrizio Fiorani

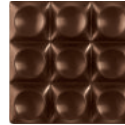

mm 70×70×10,5 h
~ 50 g
6 impronte / indents
Dim stampo / Mould
size: mm 275×175
BPA free

PC5010
Bricks
by Fabrizio Fiorani

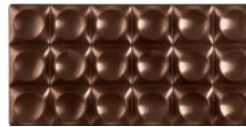

mm 154×77×9 h
~ 100 g
3 impronte / indents
Dim stampo / Mould
size: mm 275×175
BPA free



PC5012
Pixie
by Fabrizio Fiorani



mm 154×77×11 h
~ 100 g
3 impronte / indents
Dim stampo / Mould
size: mm 275×175
BPA free

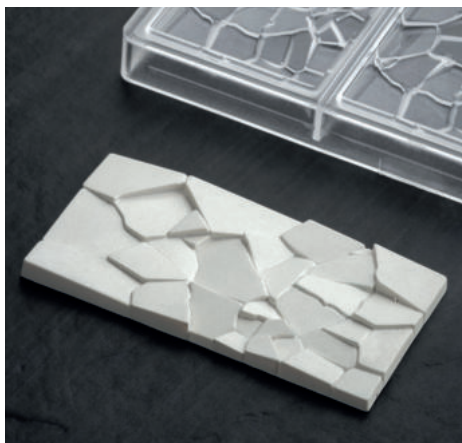

PC5002
Crush
by Fabrizio Fiorani



mm 155×77×10 h
~ 100 g
3 impronte / indents
Dim stampo / Mould
size: mm 275×175
BPA free



PC5003
Ola
by Fabrizio Fiorani



mm 155×77×10 h
~ 100 g
3 impronte / indents
Dim stampo / Mould
size: mm 275×175
BPA free



PC5029
Hexa
by Vincent Vallée



mm 154×77×10 h
~ 100 g
3 impronte / indents
Dim stampo / Mould
size: mm 275×175
BPA free



PC5030
Fluid
by Vincent Vallée

mm 154×77×11 h
~ 100 g
3 impronte / indents
Dim stampo / Mould
size: mm 275×175
BPA free



PC5014
Mini Moulin
by Vincent Vallée

mm 70×70×14 h
~ 50 g
6 impronte / indents
Dim stampo / Mould
size: mm 275×175
BPA free

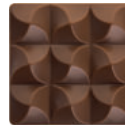

PC5009
Moulin
by Vincent Vallée

mm 154×77×14 h
~ 100 g
3 impronte / indents
Dim stampo / Mould
size: mm 275×175
BPA free





PC5004
Fragment
 by Vincent Vallée



mm 155×77×10 h
 ~ 100 g
 3 impronte / indents
 Dim stampo / Mould
 size: mm 275×175
 BPA free

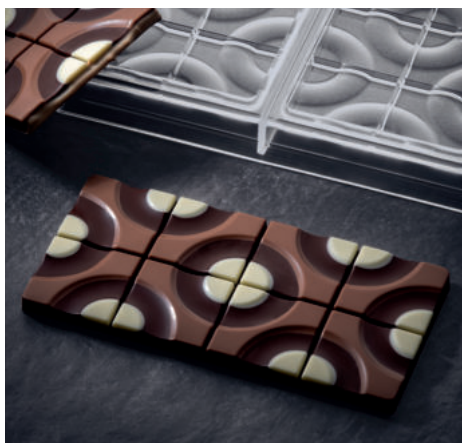

PC5008
Target
 by Vincent Vallée



mm 154×77×8 h
 ~ 100 g
 3 impronte / indents
 Dim stampo / Mould
 size: mm 275×175
 BPA free



PC5007
Flow
 by Vincent Vallée



mm 154×77×8 h
 ~ 100 g
 3 impronte / indents
 Dim stampo / Mould
 size: mm 275×175
 BPA free

Stampi per tavolette / Choco bar moulds



PC5006
Pavé
by Vincent Vallée



mm 155×78×10 h
~ 100 g
3 impronte / indents
Dim stampo / Mould
size: mm 275×175
BPA free



PC5005
Edelweiss
by Vincent Vallée



mm 155×77×10 h
~ 100 g
3 impronte / indents
Dim stampo / Mould
size: mm 275×175
BPA free



KS50
Confezione per tavolette
Choco bar pack

mm 156×80×15 h

100% riciclabile nella filiera della plastica
100% recyclable in the plastic supply chain

20 pezzi per confezione / 20 pcs per box



Stampi tridimensionali
per cioccolato
*Three-dimensional
chocolate moulds*

Scopri tutti gli stampi per creare
soggetti in cioccolato per le tue feste
e per ogni occasione.

Discover all the moulds to create
chocolate subjects for your holidays
and for any occasion.

Stampi termoformati Pasqua Easter thermoformed moulds

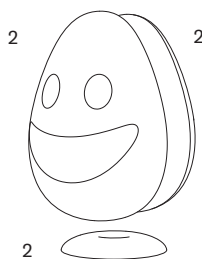

KT209
Happy

Ø mm 140×215 h
~ 340 g

PACKAGING: KS32

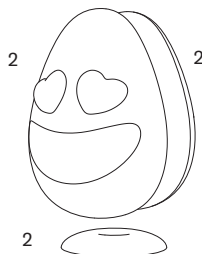

KT210
Sweety

Ø mm 140×215 h
~ 340 g

PACKAGING: KS32

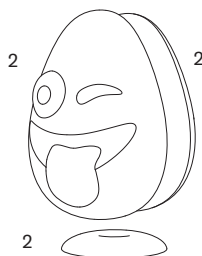

KT211
Crazy

Ø mm 140×215 h
~ 340 g

PACKAGING: KS32

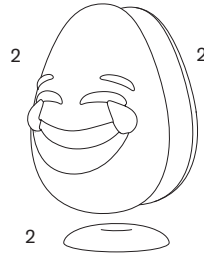
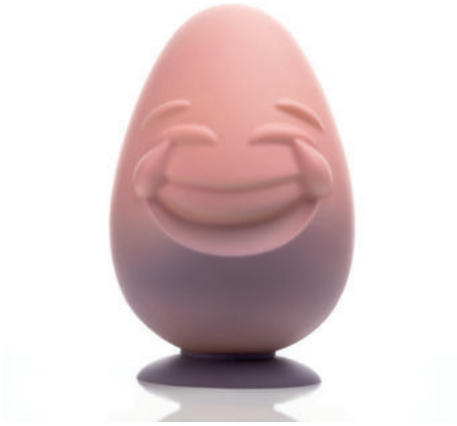

KT212
Funny

Ø mm 140×215 h
~ 340 g
PACKAGING: KS32

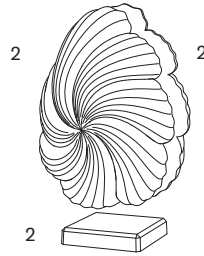

KT203
Zefiro

Ø mm 138×215 h
~ 380 g
PACKAGING: KS32

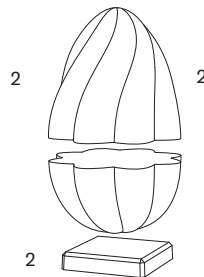

KT204
Helical

Ø mm 140×218 h
~ 480 g

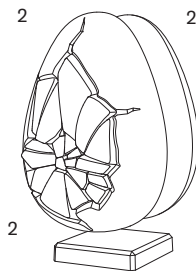

KT195
Knock

Ø mm 138×215 h
~ 450 g

PACKAGING: KS32

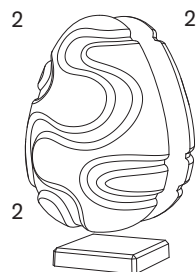

KT196
Flow
by Vincent Vallée

Ø mm 138×216 h
~ 420 g

PACKAGING: KS32

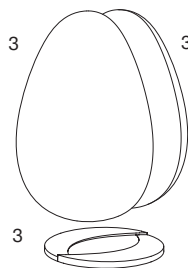

KT197
Pure

Ø mm 138×215 h
~ 400 g

PACKAGING: KS32

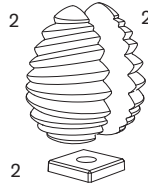

KT186
Pagoda

mm 98×98×151 h
~ 150 g

PACKAGING: KS26

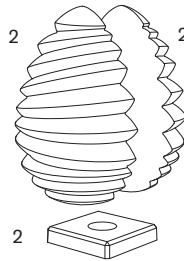

KT187
Pagoda

mm 137×137×212 h
~ 300 g

PACKAGING: KS32

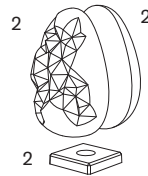

KT188
Picasso

Ø mm 96×150 h
~ 170 g

PACKAGING: KS26

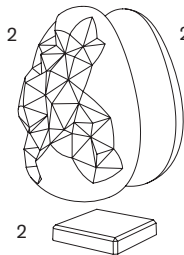

KT172
Picasso

Ø mm 140×215 h
~ 450 g

PACKAGING: KS32

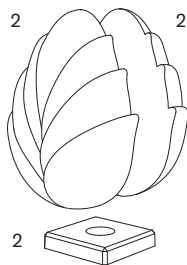

KT190
Blossom

mm 144×133×212 h
~ 370 g

PACKAGING: KS32

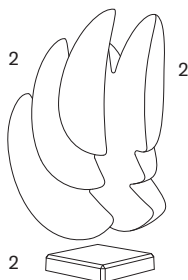

KT182
Sydney

mm 140×125×250 h
~ 390 g

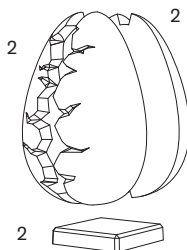

KT183
Abyss
by Davide Comaschi

Ø mm 140×215 h
~ 340 g

PACKAGING: KS32

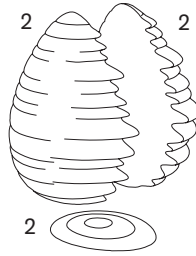

KT138
Speed

mm 135×165×200 h
~ 430 g

PACKAGING: KS32

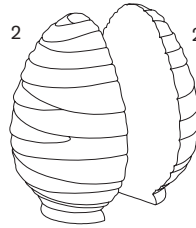

KT139
Ramses

Ø mm 140×200 h
~ 330 g

PACKAGING: KS32

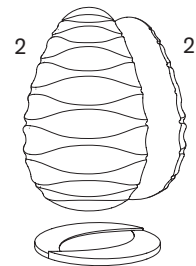

KT157
Beauty

Ø mm 130×205 h
~ 400 g

PACKAGING: KS32



Guarda i video sul canale
Youtube di Pavoni Italia
Watch the videos on Pavoni
Italia's Youtube channel



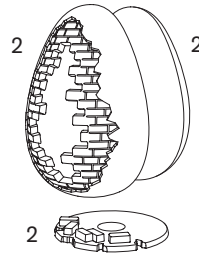

KT168
The Wall

Ø mm 140×200 h
~ 420 g

PACKAGING: KS32

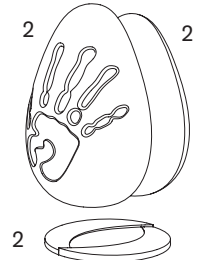

KT156
Hello

Ø mm 130×205 h
~ 380 g

PACKAGING: KS32

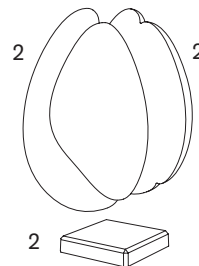

KT174
Grain

Ø mm 135×215 h
~ 400 g

PACKAGING: KS32

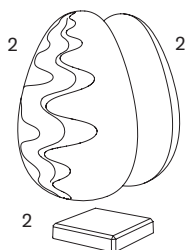

KT173
Senna

Ø mm 140×215 h
~ 450 g

PACKAGING: KS32

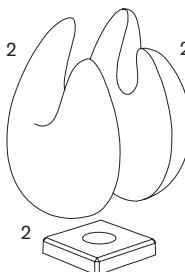

KT140
Organic

Ø mm 135×215 h
~ 330 g

PACKAGING: KS32



KT130
Squeezer

Ø mm 120×250 h
~ 300 g

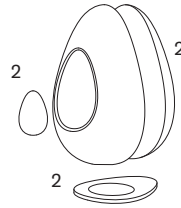

KT50
Lamp

Ø mm 110×160 h
~ 300 g

PACKAGING: KS26

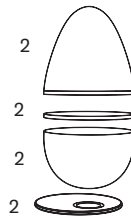

KT51
Deck

mm 135×100×165 h
~ 300 g

PACKAGING: KS26

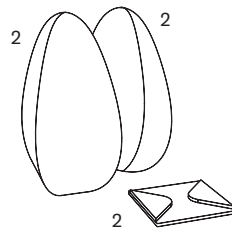

KT70
Stele

mm 90×90×200 h
~ 350 g

PACKAGING: KS26

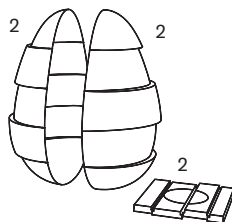

KT74
Split

Ø mm 140×200 h
~ 400 g

PACKAGING: KS32

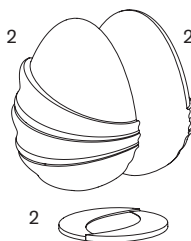

KT76
Wrap

Ø mm 150×200 h
~ 350 g

PACKAGING: KS32

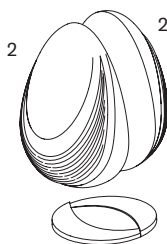

KT77
Comb

Ø mm 140×200 h
~ 350 g

PACKAGING: KS32

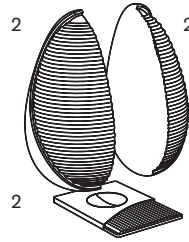
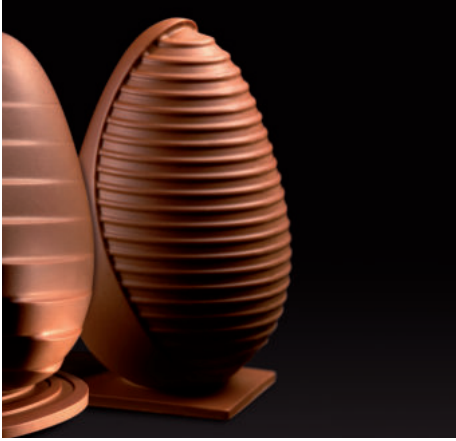

KT90
Stripe

Ø mm 130×200 h
~ 350 g

PACKAGING: KS26



KT91
Mirror

Ø mm 130×200 h
~ 350 g

PACKAGING: KS26

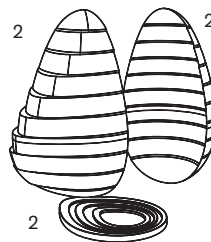

KT92
Galà

Ø mm 130×200 h
~ 350 g

PACKAGING: KS26

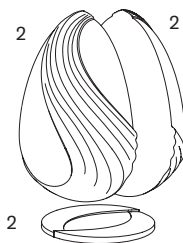

KT78
Pinup

Ø mm 140×200 h
~ 350 g

PACKAGING: KS32

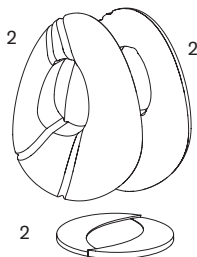

KT79
Spaceship

Ø mm 140×200 h
~ 350 g

PACKAGING: KS32

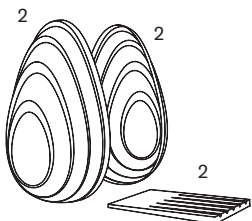

KT72
Level

Ø mm 130×200 h
~ 400 g

PACKAGING: KS26

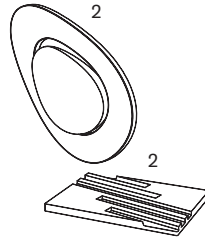

KT71
Swing

mm 130×90×200 h
~ 250 g

PACKAGING: KS26

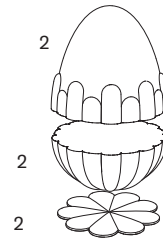

KT129
Nest

Ø mm 150×200 h
~ 400 g

PACKAGING: KS32

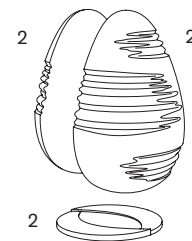

KT169
Nick

Ø mm 130×200 h
~ 380 g

PACKAGING: KS26

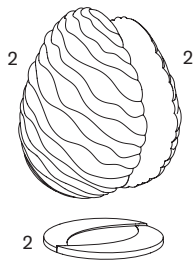

KT158
Fluid

Ø mm 140x205 h
~ 380 g

PACKAGING: KS32

credits: Carlo Cracco

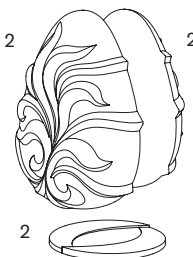

KT167
Barocco

Ø mm 145x200 h
~ 420 g

PACKAGING: KS32



KT198
Rafael

mm 138x132x180 h
~ 270 g

PACKAGING: KS32

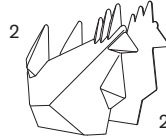

KT184
Rocky Rooster

mm 170×105×150 h
~ 120 g

PACKAGING: KS26

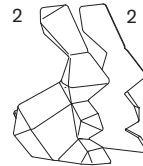

KT185
Rocky Roger

mm 145×95×180 h
~ 170 g

PACKAGING: KS26

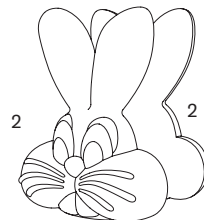

KT170
Roger

mm 155×110×200 h
~ 270 g

PACKAGING: KS26

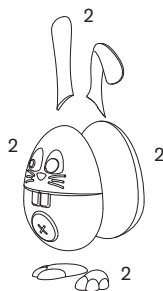

KT131
Eddie

Ø mm 100×210 h
~ 170 g

PACKAGING: KS32

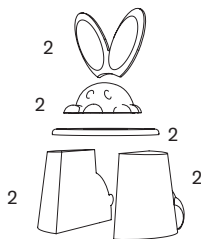

KT154
Magic Bunny

mm 100×120×170 h
~ 200 g

PACKAGING: KS26



KT189
Bomber

mm 132×125×160 h
~ 200 g

PACKAGING: KS26

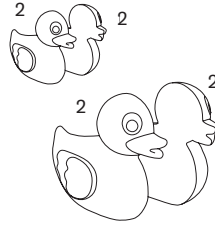

KT142
Papera+Paperella

2 soggetti / 2 items

mm 60×45×75 h
~ 40 g

mm 112×80×136 h
~ 120 g

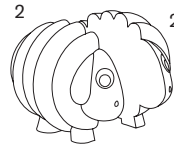

KT143
Pecorella

mm 160×100×125 h
~ 180 g

PACKAGING: KS26

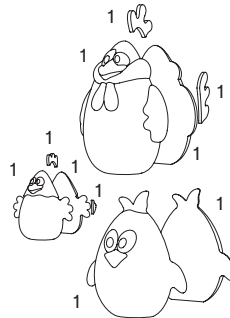

KT155
Kit Chicken Family

3 soggetti / 3 items

mm 120×135×190 h
~ 200 g

mm 135×110×145 h
~ 150 g

mm 85×75×90 h
~ 90 g

Stampi termoformati Natale Christmas thermoformed moulds



Guarda il video sul canale
Youtube di Pavoni Italia
Watch the video on Pavoni
Italia's Youtube channel

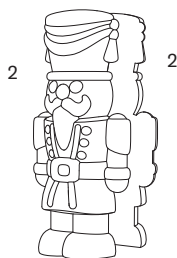

KT215
Nutcracker

mm 90×70×200 h
~ 180 g

PACKAGING KS26



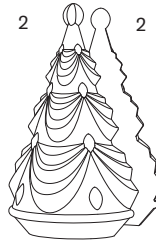

KT213
Drappo

Ø mm 120×200 h
~ 250 g

PACKAGING KS32

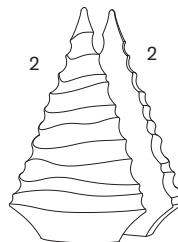

KT214
Chiffon

Ø mm 130×200 h
~ 250 g

PACKAGING KS32

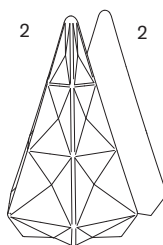

KT205
Hexagon Tree
by Davide Comaschi

Ø mm 135×200 h
~ 200 g

PACKAGING KS32

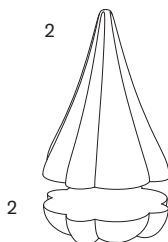

KT207
Fluent Tree
by Davide Comaschi

Ø mm 140×200 h
~ 200 g

PACKAGING KS26

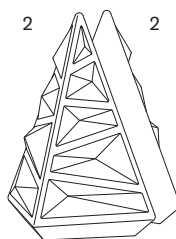
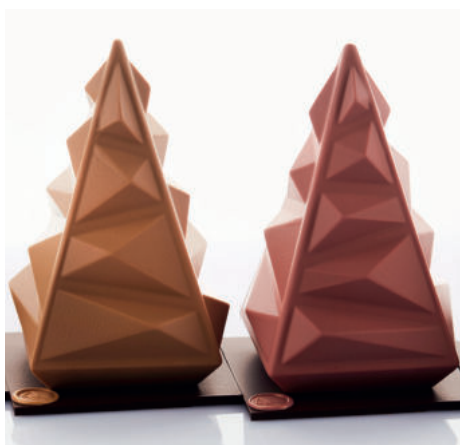

KT194
Rocky Tree
by Davide Comaschi

mm 125×125×195 h
~ 280 g

PACKAGING: KS26

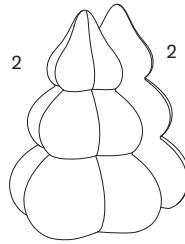

KT206
Blob Tree
 by Davide Comaschi

Ø mm 155×200 h
 ~ 250 g

PACKAGING KS32



KT136
Wave

Ø mm 160×200 h
 ~ 260 g

PACKAGING: KS32

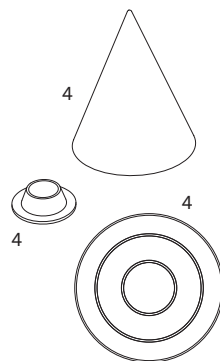

KT16
Albero a cono

Ø mm 110×160 h
 ~ 250 g

PACKAGING: KS26

KT20
Albero a cono

Ø mm 140×210 h
 ~ 350 g

PACKAGING: KS32

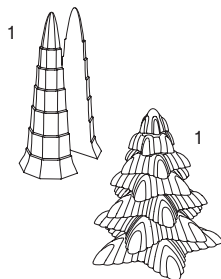

KT177
Fringe

Ø mm 135×150 h
~ 350 g

PACKAGING: KS32

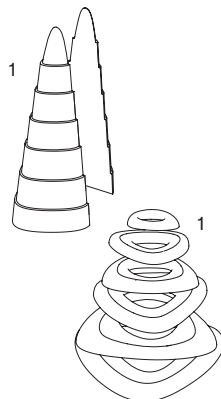

KT176
Saturno

Ø mm 165×195 h
~ 450 g

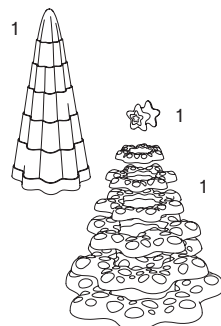

KT162
Ring

Ø mm 160×200 h
~ 500 g

PACKAGING: KS32



KT135
Albero Animato

mm 160×75×200 h
~ 250 g

PACKAGING: KS26

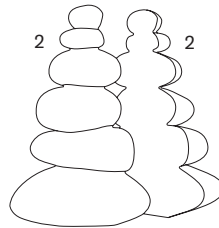

KT137
Zen

Ø mm 160×200 h
~ 290 g

PACKAGING: KS32

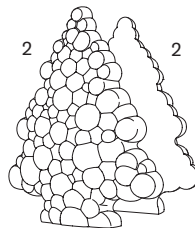

KT152
Bolla

mm 160×65×200 h
~ 250 g

PACKAGING: KS26

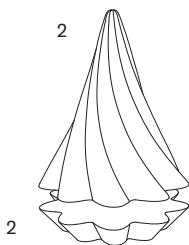

KT199
Twirl

Ø mm 150×200 h
~ 250 g

PACKAGING: KS32

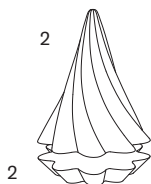

KT200
Mini Twirl

Ø mm 112×150 h
~ 110 g

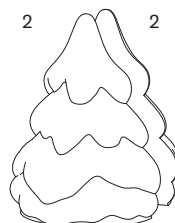

KT191
Snow Tree

Ø mm 145×185 h
~ 200 g

PACKAGING: KS26



KT192
Mini Snow Tree

Ø mm 95×120 h
~ 100 g

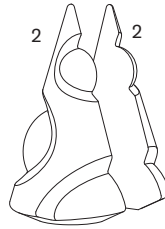

KT178
Merlin

Ø mm 120×200 h
~ 180 g

PACKAGING: KS26

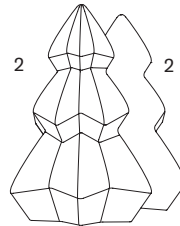
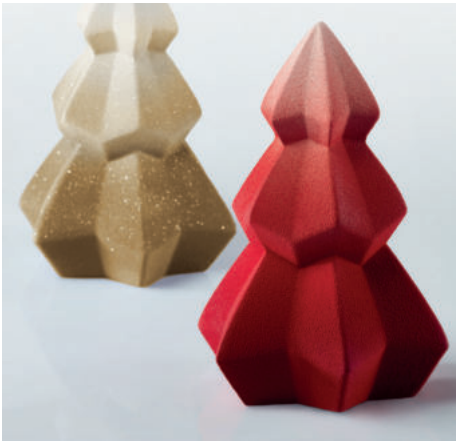

KT151
Crystal

Ø mm 145×200 h
~ 180 g

PACKAGING: KS32

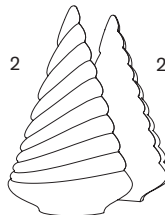

KT150
Soft

Ø mm 125×195 h
~ 200 g

PACKAGING: KS26

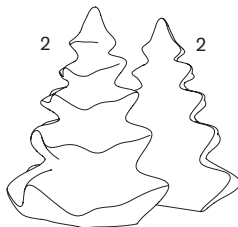

KT163
Tutu

Ø mm 140×150 h
~ 200 g

PACKAGING: KS32

KT164
Tutu

Ø mm 170×200 h
~ 320 g

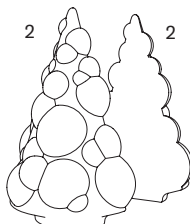

KT175
Ampolla

Ø mm 135×200 h
~ 200 g

PACKAGING: KS32

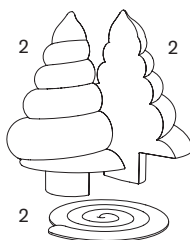

KT125
Spirale

Ø mm 160×210 h
~ 350 g

PACKAGING: KS32

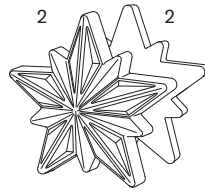

KT208
Polaris
by Davide Comaschi

mm 172×164×75 h
~ 150 g

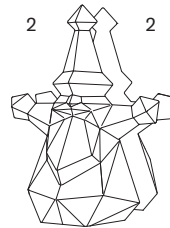

KT201
Santa Hug

mm 152×115×200 h
~ 230 g

PACKAGING: KS26

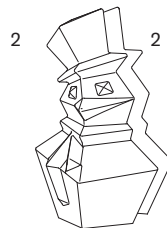

KT202
Snowman

mm 125×121×200 h
~ 200 g

PACKAGING: KS26



KT193
Comfort Teddy

mm 185×110×106 h
~ 230 g

PACKAGING: KS26

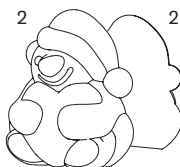

KT166
Teddy

mm 120×115×140 h
~ 250 g

PACKAGING: KS26



KT148
Angelo

mm 155×75×150 h
~ 150 g

PACKAGING: KS26

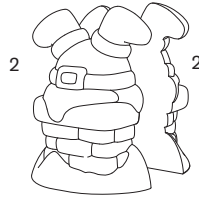

KT179
Santa Chimney

Ø mm 125×170 h
~ 380 g

PACKAGING: KS26

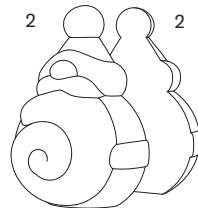

KT180
Santa Twist

Ø mm 140×180 h
~ 280 g

PACKAGING: KS32

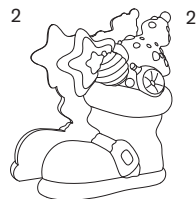

KT181
Santa Boot

mm 160×80×180 h
~ 390 g

PACKAGING: KS26

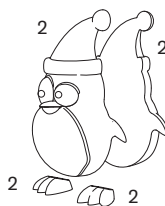

KT120
Pinguino

mm 130×105×170 h
~ 250 g

PACKAGING: KS26

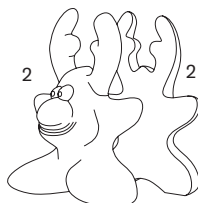

KT133
Renna

mm 145×90×175 h
~ 200 g

PACKAGING: KS26

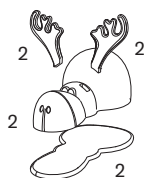
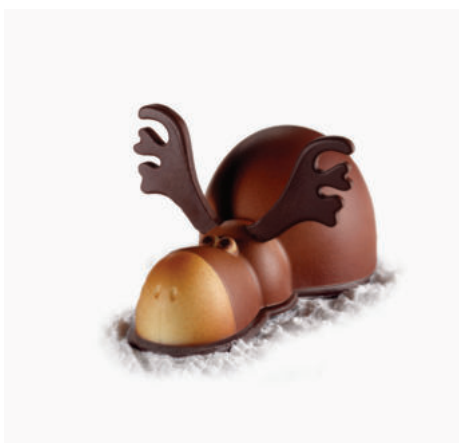

KT86
Rudolph

mm 195×100×100 h
~ 235 g

PACKAGING: KS26

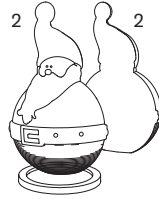

KT122
Babbo

Ø mm 105×170 h
~ 200 g

PACKAGING: KS26

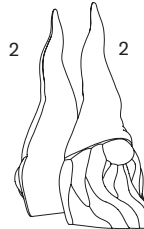

KT165
Gnomo

mm 115×85×200 h
~ 200 g

PACKAGING: KS26

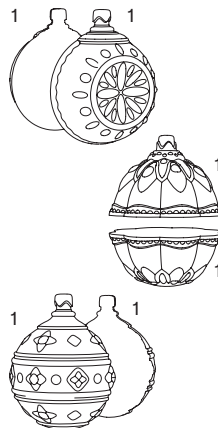

KT149
Xmas Balls

mm 100×75×120 h
Ø mm 105×120 h
Ø mm 100×120 h
~ 90 g cad./ each

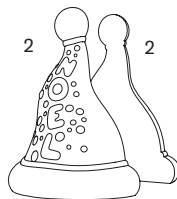

KT153
Noel

Ø mm 130×170 h
~ 180 g

PACKAGING: KS26

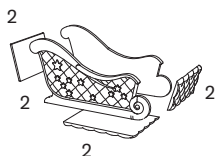

KT127
Slitta

mm 180×100×90 h
~ 200 g

PACKAGING: KS26

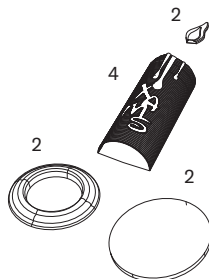

KT87
Candela

Ø mm 110×200 h
~ 215 g

PACKAGING: KS26

Stampi termoformati e magnetici Thermoformed and magnetic moulds



KT159
Semisfere

Kit 3 semisfere /
Kit 3 hemispheres
Ø mm 80
Ø mm 100
Ø mm 120

KT160
Semisfere

Kit 3 semisfere /
Kit 3 hemispheres
Ø mm 140
Ø mm 160
Ø mm 180

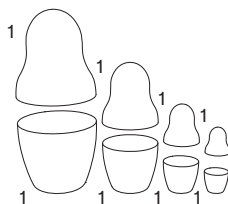

KTMATRIOSKA
Matrioska
by Olga Penioza

4 soggetti / 4 items
mm 200 - 150 - 100 - 50 h

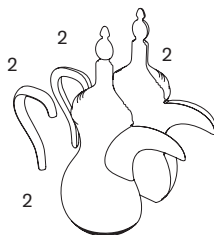

KTDALLAH
Dallah

mm 178×96×230 h
~ 320 g

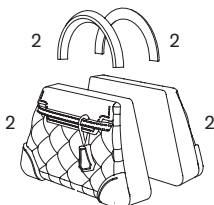

KT123
Borsetta

mm 165×80×150 h
~ 220 g

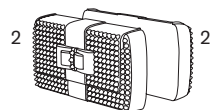

KT146
Pochette

mm 155×70×90 h
~ 170 g

BPA free



SH02
Zeppa

mm 170×70×155 h
~ 160 g

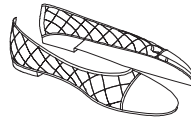

SH01
Ballerina

mm 185×65×50 h
~ 90 g

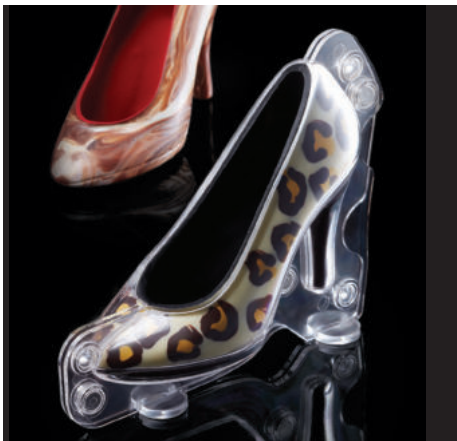

SCARPADECOLTE
Scarpetta

mm 150×70×120 h
~ 150 g



Stampi termoformati serigrafati

Silkscreened thermoformed moulds

Aggiungi il cioccolato preferito e realizza creazioni sempre perfette per donare un tocco di creatività ai tuoi prodotti. Proposte uniche per Natale, Pasqua e tutte le occasioni speciali.

Add your favorite chocolate and create perfect creations to give a touch of creativity to your products. Unique proposals for Christmas, Easter and all your special occasions.

Pasqua Easter

Misura foglio / Sheet size: mm 340x265
 10 fogli per confezione / 10 sheets per box
 Il numero di impronte si intende per scatola /
 The number of indents is per box

 Cioccolato fondente
Dark chocolate

 Cioccolato bianco
White chocolate

 Cioccolato al latte
Milk chocolate

 Colori perlescenti
Pearly colours

 E171 free

 AZO free



T1022SB*

mm 50 h
 rosa, rosso, giallo,
 marrone / pink,
 red, yellow, brown
 200 impronte /
 200 indents

utilizzare solo con /
 use only with



New Product
 T1037SB

Ø mm 29 h - 2 design
 rosa, verde, giallo, marrone /
 pink, green, yellow, brown
 1000 impronte / indents

utilizzare solo con /
 use only with



T1023SB

mm 40 h
 rosa, rosso, verde /
 pink, red, green
 540 impronte /
 540 indents

utilizzare solo con /
 use only with



New Product
 T1038SB

Ø mm 22x30 h - 3 design
 giallo, verde, rosso, nero /
 yellow, green, red, black
 1000 impronte / indents

utilizzare solo con /
 use only with



T1024SB

mm 40 h
 giallo, fucsia, verde /
 yellow, fuchsia, green
 540 impronte /
 540 indents

utilizzare solo con /
 use only with





T1025SB

mm 35 h
arancione, giallo,
rosso, nero / orange,
yellow, red, black
540 impronte /
540 indents

utilizzare solo con /
use only with



T1026SB

mm 35 h
nero, rosa /
black, pink
480 impronte /
480 indents

utilizzare solo con /
use only with



T1027SB

mm 43x63 h
azzurro, rosso, nero,
celeste / light blue,
red, black, sky blue
240 impronte /
240 indents

utilizzare solo con /
use only with



T1028SB

mm 26x40 h
verde, rosso,
arancione, giallo /
green, red,
orange, yellow
450 impronte /
450 indents

utilizzare solo con /
use only with



T1029SB

mm 43x63 h
giallo, nero, rosso,
marrone, azzurro /
yellow, black, red,
brown, light blue
240 impronte /
240 indents

utilizzare solo con /
use only with



T1030SB

mm 26x40 h
rosso, arancione,
verde / red,
orange, green
450 impronte /
450 indents

utilizzare solo con /
use only with



T1031SB

mm 43x63 h
verde, arancione,
marrone scuro /
green, orange,
dark brown
240 impronte /
240 indents

utilizzare solo con /
use only with

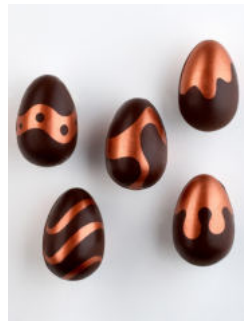

T1032SB ✨

mm 26x40 h
bronzo / bronze
450 impronte /
450 indents

utilizzare solo con /
use only with



Natale Christmas

Misura foglio / Sheet size: mm 340x265
 10 fogli per confezione / 10 sheets per box
 Il numero di impronte si intende per scatola /
 The number of indents is per box

 Cioccolato fondente
Dark chocolate

 Cioccolato bianco
White chocolate

 E171 free

 Cioccolato al latte
Milk chocolate

 Colori perlescenti
Pearly colours

 AZO free



T1033SB

Ø mm 35
 rosso / red
 630 impronte /
 630 indents

utilizzare solo con /
 use only with



T1034SB ✨

mm 57-51 h
 rubino, bronzo /
 ruby, bronze
 480 impronte / 480 indents

utilizzare con /
 use with



T1035SB ✨

Ø mm 30 h - 5 design
 rubino / ruby
 630 mezze sfere /
 630 hemispheres

utilizzare con /
 use with





T1000SB ✨

Ø mm 40 h
rame, nero - oro,
nero / copper,
black - gold, black
480 mezza sfere /
480 hemispheres

utilizzare con /
use with



T1001SB ✨

Ø mm 70 h
rubino, rame /
ruby, copper
120 mezza sfere /
120 hemispheres

utilizzare con /
use with



T1036SB ✨

Ø mm 40 h - 4 design
rame / copper
480 mezza sfere /
480 hemispheres

utilizzare con /
use with



T1002SB ✨

Ø mm 30 h
rame, oro /
copper, gold
630 mezza sfere /
630 hemispheres

utilizzare con /
use with



T1003SB

mm 40 h
rosa, rosso, nero /
pink, red, black
480 impronte /
480 indents

utilizzare solo con /
use only with



T1004SB

mm 40 h
rosso, nero /
red, black
480 impronte /
480 indents

utilizzare solo con /
use only with





T1005SB

mm 53 h
marrone, rosso, rosa
/ brown, red, pink
300 impronte /
300 indents

utilizzare solo con /
use only with



T1006SB

mm 48 h
rosso, rosa, nero /
red, pink, black
360 impronte /
360 indents

utilizzare solo con /
use only with



T1007SB

mm 55 h
rosso, rosa, marrone
/ red, pink, brown,
240 impronte /
240 indents

utilizzare solo con /
use only with



T1008SB

mm 45 h
verde, rosso, marrone,
rosa / green, red,
brown, pink
300 impronte /
300 indents

utilizzare solo con /
use only with



T1009SB

mm 60 h
rosso, marrone
chiaro e scuro / red,
light and dark brown
280 impronte /
280 indents

utilizzare solo con /
use only with



T1010SB

mm 40 h
marrone scuro e
chiaro, giallo, rosso /
dark and light brown,
yellow, red
480 impronte /
480 indents

utilizzare solo con /
use only with



T1011SB

mm 42 h
rosso, arancione,
nero / red,
orange, black
800 impronte /
800 indents

utilizzare solo con /
use only with



T1012SB

mm 45 h
verde, rosso, nero /
green, red, black
350 impronte /
350 indents

utilizzare solo con /
use only with





T1013SB

mm 50 h
rosso, verde /
red, green
360 impronte /
360 indents

utilizzare solo con /
use only with



T1014SB

mm 60 h
rosso, verde, marrone
scuro, giallo / red,
green, dark brown,
yellow
200 impronte /
200 indents

utilizzare solo con /
use only with



T1015SB ✨

mm 52 h
rubino, oro /
ruby, gold
400 impronte /
400 indents

utilizzare con /
use with

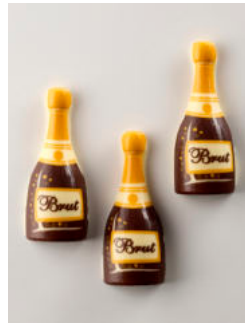

T1016SB

mm 68 h
giallo, marrone /
yellow, brown
400 impronte /
400 indents

utilizzare solo con /
use only with



T1017SB*

mm 60 h
marrone, rosso,
giallo, beige / brown,
red, yellow, beige
200 impronte /
200 indents

utilizzare solo con /
use only with



T1018SB*

Ø mm 50
azzurro, rosso, verde,
arancione, nero /
light blue, red, green,
orange, black
200 impronte /
200 indents

utilizzare solo con /
use only with



PZ20SB

mm 190×130 h
rosso, rosa, marrone, giallo, azzurro /
red, pink, brown, yellow, light blue
il kit contiene 10 puzzle - 10 fogli in PVC - 10 buste /
kit contains 10 puzzle - 10 PVC sheets - 10 bags

utilizzare solo con /
use only with



Collection

Misura foglio / Sheet size: mm 340x265
 10 fogli per confezione / 10 sheets per box
 Il numero di impronte si intende per scatola /
 The number of indents is per box

 Cioccolato fondente
 Dark chocolate

 Cioccolato bianco
 White chocolate

 E171 free

 Cioccolato al latte
 Milk chocolate

 Colori perlescenti
 Pearly colours

 AZO free



T1020SB
 Evidenziatore / Marker

lunghezza / length mm 90
 rosa, verde, arancione /
 pink, green, orange
 300 impronte - 150 evidenziatori /
 300 indents - 150 markers

utilizzare solo con /
 use only with



T1021SB
 Matita / Pencils Size S

lunghezza / length mm 80
 rosa, azzurro, arancione, verde,
 giallo, rosso / pink, light blue,
 orange, green, yellow, red
 600 impronte - 300 matite /
 600 indents - 300 pencils

utilizzare solo con /
 use only with



T1019SB
 Matita / Pencils Size L

lunghezza / length mm 220
 rosa, azzurro, arancione, verde,
 giallo, rosso / pink, light blue,
 orange, green, yellow, red
 12 impronte - 6 matitone /
 12 indents - 6 big pencils

utilizzare solo con /
 use only with





TFOOT-30SB

Ø mm 30
nero / black
630 mezze sfere /
630 hemispheres

utilizzare solo con /
use only with



TFOOT-70SB

Ø mm 70
nero / black
120 mezze sfere /
120 hemispheres

utilizzare solo con /
use only with



T114SB

Ø mm 50
giallo, marrone /
yellow, brown
200 impronte /
200 indents

utilizzare solo con /
use only with



Il kit include
200 sacchetti +
200 bastoncini /
The kit includes
200 bags +
200 paper sticks

KS30
200 bastoncini /
sticks

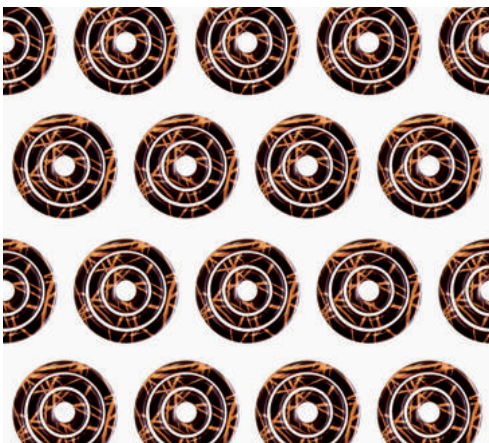

T405SB

Ø mm 60 - 42 - 25
rame / copper
200 impronte /
200 indents

utilizzare con /
use with





Serigrafie

Silkscreens

Le serigrafie permettono di creare velocemente decorazioni di grande effetto. I fogli vengono serigrafati con colori a base di burro di cacao e di facile utilizzo.

Silkscreens allow you to quickly create highly effective decorations. The sheets are screen-printed with easy-to-use cocoa butter-based colors.

Serigrafie Silkscreens

Misura foglio / Sheet size: mm 340x265
30 fogli per scatola confezionati in pacchetti da 10. / Each box contains 30 sheets wrapped in packs of 10.

 Cioccolato fondente
Dark chocolate

 Cioccolato bianco
White chocolate

 Cioccolato al latte
Milk chocolate

 Colori perlescenti
Pearly colours

 E171 free

 AZO free

Natale Christmas



SD231SB

rosso / red

utilizzare con /
use with



SD232SB

rosso / red

utilizzare con /
use with



SD221SB

giallo / yellow

utilizzare con /
use with



SD223SB

giallo, rosso /
yellow, red

utilizzare con /
use with



Pasqua Easter



SD226SB

marrone, rosa /
brown, pink

utilizzare solo con /
use only with



Love



SD234SB

magenta, nero /
magenta, black

utilizzare solo con /
use only with



SD233SB

magenta / magenta

utilizzare solo con /
use only with



SD224SB

rosso / red

utilizzare con /
use with



SD235SB

rosso / red

utilizzare con /
use with



SD225SB

rosso, nero /
red, black

utilizzare solo con /
use only with



Collection



SD227SB ✨

oro / gold

utilizzare con /
use with

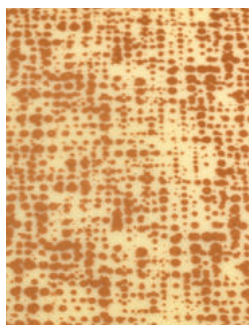

SD228SB ✨

rame / copper

utilizzare con /
use with

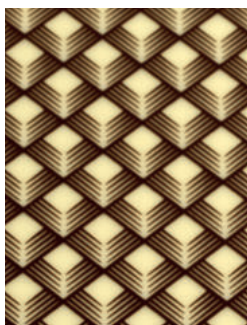

SD229SB

marrone / brown

utilizzare solo con /
use only with



SD230SB ✨

oro / gold

utilizzare con /
use with



SD200SB ✨

bronzo / bronze

utilizzare con /
use with



SD201SB

arancione, verde /
orange, green

utilizzare con /
use with



SD202SB

giallo / yellow

utilizzare con /
use with



Serigrafie / Silkscreens



SD203SB

giallo / yellow

utilizzare con /
use with

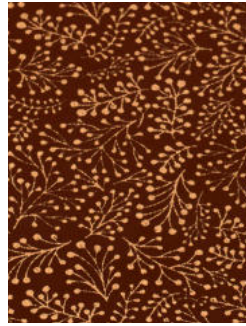

SD204SB ✦

rame / copper

utilizzare con /
use with

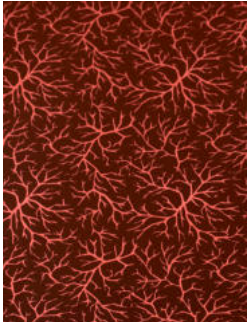

SD205SB ✦

rubino / ruby

utilizzare con /
use with



SD206SB ✦

rubino, bronzo /
ruby, bronze

utilizzare con /
use with

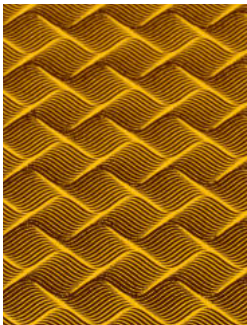

SD207SB

giallo / yellow

utilizzare con /
use with

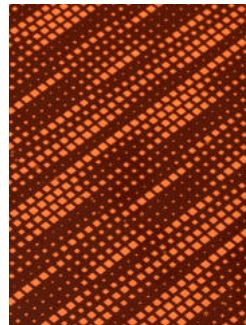

SD208SB

arancione / orange

utilizzare con /
use with

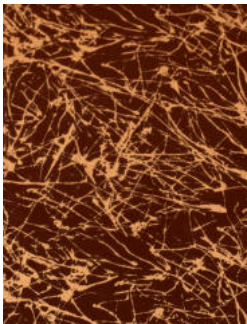

SD209SB ✦

bronzo / bronze

utilizzare con /
use with

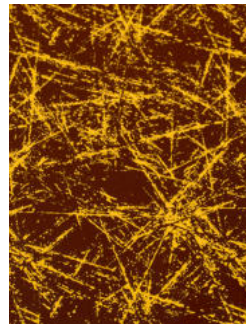

SD210SB

giallo / yellow

utilizzare con /
use with



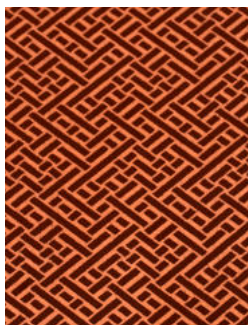

SD211SB ✨

rame / copper

utilizzare con /
use with

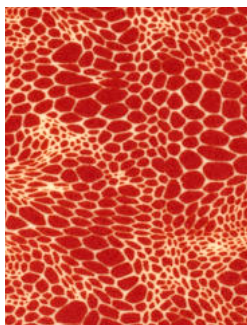

SD212SB ✨

rubino, / ruby

utilizzare con /
use with

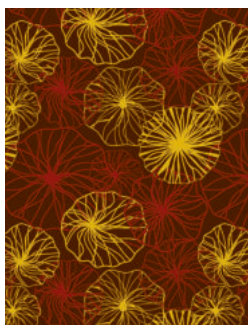

SD213SB

giallo, rosso /
yellow, red

utilizzare con /
use with



SD214SB

giallo, rosso,
arancione / yellow,
red, orange

utilizzare con /
use with

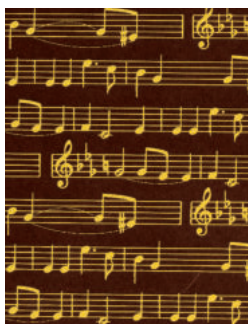

SD215SB

giallo / yellow

utilizzare con /
use with

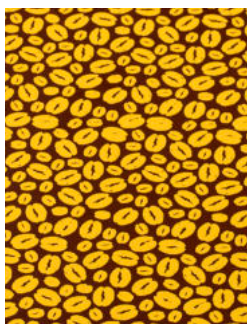

SD216SB

giallo / yellow

utilizzare con /
use with



SD217SB

verde chiaro
e scuro / light
and dark green

utilizzare solo con /
use only with



SD218SB

marrone / brown

utilizzare solo con /
use only with



Serigrafie / Silkscreens



SD219SB

magenta / magenta

utilizzare solo con /
use only with

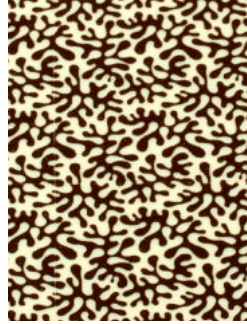

SD220SB

marrone / brown

utilizzare solo con /
use only with



SD120SB
Camouflage
by Massimo Bottura

utilizzare solo con /
use only with



SD4COLSB
Camouflage
by Massimo Bottura

utilizzare solo con /
use only with





Transfer e blister personalizzati

Custom transfer and blister

Puoi apporre il tuo logo o la tua firma su tanti prodotti diversi:

- placchette in cioccolato extrasottili
- fogli termoformati, vuoti o pre-riempiti
- fogli serigrafati, da utilizzare con o senza chablon

Inviaci il tuo design a info@pavonitalia.com per avere una proposta personalizzata.

You can put your logo or signature on many different products:

- extra-thin chocolate plaques
- thermoformed sheets, empty or prefilled
- silkscreened sheets, to be used with or without chablon.

Send us your design to info@pavonitalia.com to have a customized proposal.

Transfer e blister personalizzati *Custom transfer and blister*

**Placchette in cioccolato
extrasottili**
**Extra-thin chocolate
plaques**

LOGO:
da 1 a 4 colori

QUANTITÀ MINIMA:
10 confezioni
(5 fogli a confezione)

CIOCCOLATO:
bianco, latte o fondente

LOGO:
from 1 to 4 colours

MINIMUM QUANTITY:
10 boxes
(5 sheets per box)

CHOCOLATE:
white, milk, dark



Tonde / Round

	Code	Dimension (mm)	Pezzi per scatola Pcs per box
	P203	Ø 10	760
	P216	Ø 18	560
	P110	Ø 20	450
	P205	Ø 25	275
	P418	Ø 30	210
	P204	Ø 35	180
	P417	Ø 40	160
	P157	Ø 45	105
	P078	Ø 50	105

Ovale / Oval

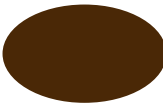
	Code	Dimension (mm)	Pezzi per scatola Pcs per box
	P109	25×15	520
	P150	30×20	300
	P002/335	42×25	200
	P332	30×40	190
	P521	60×26	204
	P397	72×25	125



Quadrato / Square

	Code	Dimension (mm)	Pezzi per scatola Pcs per box
	P170	13×13	1485
	P096	15×15	1250
	P004/105	20×20	630
	P041/136	25×25	450
	P005/065	30×30	300
	P012/365	37×37	180
	P073	40×40	135
	P021/127	50×50	105

Rettangolare / Rectangular

	Code	Dimension (mm)	Pezzi per scatola Pcs per box
	P168	20×8	1620
	P219	35×9	450
	P468	60×10	450
	P428	120×12	360
	P020	30×15	600
	P057/131	70×15	250
	P156	40×16	405
	P348	25×20	540
	P037	55×20	210
	P003/108	37,5×14	300
	P074	50×25	210
	P056	70×25	150
	P339	35×30	250
	P030	55×30	150
	P023/135	50×36	150
	P075	60×40	90

Cuore / Heart

	Code	Dimension (mm)	Pezzi per scatola Pcs per box
	P048	32×29	200
	P115	34×33	200
	P011	30×30	300
	P012	37,5×37,5	200
	P053	50×50	105

Blister

Vuoti o pre-riempiti con cioccolato fondente, bianco o al latte. Completamente personalizzabili. / Empty or pre-filled with dark, white or milk chocolate. Fully customizable.

BLISTER VUOTI

LOGO:
da 1 a 4 colori

QUANTITÀ MINIMA:
2 confezioni
(50 fogli a confezione)

BLISTER PRE-RIEMPITI

LOGO:
da 1 a 4 colori

QUANTITÀ MINIMA:
10 confezioni
(5 fogli a confezione)

CIOCCOLATO:
bianco, al latte e
fondente

EMPTY BLISTER

LOGO:
from 1 to 4 colours

MINIMUM QUANTITY:
2 boxes
(50 sheets per box)

PRE-FILLED BLISTER

LOGO:
from 1 to 4 colours

MINIMUM QUANTITY:
10 boxes
(5 sheets per box)

CHOCOLATE:
white, milk and dark





Tondo / Round

	Code	Dimension (mm)	Impronte per foglio Indents per sheet	
	B181	Ø 24	120	senza bordo / without frame
	B139	Ø 30	72	senza bordo / without frame
	B159	Ø 40	48	senza bordo / without frame



Ovale / Oval

	Code	Dimension (mm)	Impronte per foglio Indents per sheet	
	B161	33x22	90	senza bordo / without frame
	B162	40x25	72	senza bordo / without frame
	B167	47x24	70	senza bordo / without frame
	B134	57x35	36	senza bordo / without frame
	BR148	33x22	90	con bordo / with frame
	BR108	40x25	72	con bordo / with frame
	BR109	57x35	36	con bordo / with frame

Quadrato / Square

	Code	Dimension (mm)	Impronte per foglio Indents per sheet	
	B707	20x20	192	senza bordo / without frame
	B204	30x30	72	senza bordo / without frame
	B705	32x32	80	senza bordo / without frame
	BR147	40x40	72	con bordo / with frame

Rettangolare / Rectangular

	Code	Dimension (mm)	Impronte per foglio Indents per sheet	
	B702	60x8	120	senza bordo / without frame
	B197	60x15	84	senza bordo / without frame
	B163	55x30	36	senza bordo / without frame
	BR149	55x30	36	con bordo / with frame

Cuore / Heart

	Code	Dimension (mm)	Impronte per foglio Indents per sheet	
	BR102	33x32	54	con bordo / with frame

Personalizza i sigilli con
il tuo logo e colori
Customize the seals with
your logo and colours

Code	Dimension (mm)	Impronte Indents
B708	Ø mm 35	630



Fogli serigrafati "Decocioc" Silkscreened sheets "Decocioc"

I fogli serigrafati Decocioc possono essere personalizzati con il tuo logo o design, in ordine sparso o prespaziato, in tanti chablon dalle forme diverse. /

Decocioc silkscreened sheets can be customised with your logo or design in a scattered or pre-spaced order, with a variety of chablon stencil shapes.

SERIGRAFIE:
da 1 a 4 colori

SILKSCREENED SHEETS:
from 1 to 4 colours

QUANTITÀ MINIMA:
5 confezioni, totale 250
fogli (50 fogli a scatola)

MINIMUM QUANTITY:
5 boxes, total 250 sheets
(50 sheets per box)

MISURA FOGLIO:
mm 340x265

SHEET SIZE:
mm 340x265



Fogli serigrafati con marchio in ordine sparso. /
Silkscreened sheets with logo in random order.









Fogli serigrafati con marchio prespaziato da utilizzarsi
con chablon. / Silkscreened sheets with pre-spaced
logo to be used with chablon.



Chablon per fogli serigrafati Chablon for silkscreened sheets

Tondi, quadrati, rettangolari, triangolari, a cuore, ellittici. Scegli fra le numerose forme e dimensioni di chablon (mm 340×280). / Round, square, rectangular, triangular, heart-shaped, oval. Choose from a wide range of chablon shapes and sizes (mm 340×280).

	Code	Dimension (mm)	Pezzi per scatola Pcs per box
	D25T	Ø 25	56
	D3T	Ø 30	48
	D35T	Ø 35	35
	D4T	Ø 40	30
	D40-O	40×24	36
	D45-O	45×27	30
	D3C	Ø 30	48
	D35C	Ø 35	35
	D25QR	23,5×23,5	56
	D4QR	40×40	30
	D51R	52×12	65
	D52R	52×26	35
	D38TR	38×38	66



Attrezzature per cioccolato

Chocolate equipment

Tutta la gamma di strumenti
indispensabili per la lavorazione del
cioccolato.

A complete range of essential
tools for chocolate.

Attrezzature per cioccolato

Chocolate equipment

FlyChoc

Un progetto realizzato in collaborazione con il Maestro Stefano Laghi e Filippo Re. Dieci attrezzi in acciaio inox pensati per realizzare decorazioni in cioccolato dalle forme e dimensioni diverse. Con FlyChoc piume e foglie si realizzano in modo semplice, veloce e razionale, con un risultato impeccabile. / A project developed in collaboration with pastry chefs Stefano Laghi and Filippo Re. Ten stainless steel tools to create chocolate decorations of various shapes and sizes. With FlyChoc feathers and leaves can be created simply, quickly and rationally, with an impeccable result.

Foglia larga / Large leaf



Code	Size	Foglia / Leaf Dimension (mm)
CH1	S	40×30
CH2	M	50×36
CH3	L	60×44

Foglia / Leaf



Code	Size	Foglia / Leaf Dimension (mm)
CH4	S	42×22
CH5	M	60×30
CH6	L	80×40

Piuma / Feather













Code	Size	Foglia / Leaf Dimension (mm)
CH7	S	60×20
CH8	M	80×23
CH9	L	100×24
CH10	XL	120×24

Forchettine pralineria Praline forks

Forchettine per pralineria con filo in acciaio inox. Acquistabili anche singolarmente, con i relativi codici. / Praline forks with stainless steel wire. Also sold individually, with specific codes.

SFP

Serie completa di 10 pezzi / Complete set of 10 pcs

	Code		Code
	SFP1		SFP5
	SFP9		SFP4
	SFP8		SFP3
	SFP6		SFP2
	SFP7		SFP10

Texture per decoro praline Texture for praline decoration

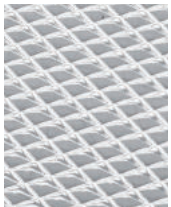
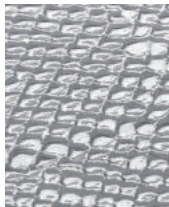
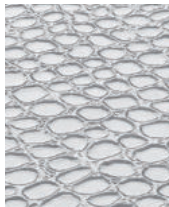

STRKIT1

32 fogli mm 400×250
4 decorazioni,
8 per tipo
32 sheets mm 400×250
4 decorations,
8 for each type

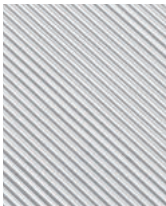

STRKIT2

32 fogli mm 400×250
4 decorazioni,
8 per tipo
32 sheets mm 400×250
4 decorations,
8 for each type



Delicious Snack

Due stampi in silicone per creare snack dolci o salati, con ripieni e golose farciture. Gli stampi possono essere utilizzati in forno, in frigorifero e abbattitore. Resistono a temperature da -40°C a + 250°C. /

Two silicone moulds to create snacks, sweet or savoury, with delicious fillings under the coating. They can be used in ovens, refrigerators and blast chillers. They can withstanding temperatures from -40°C to +250°C.

Dimensione stampo /
Mould size: mm 285x175

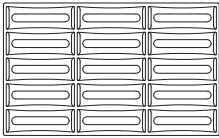

DS01

mm 90x30x19 h
~ 38 ml
15 impronte / indents

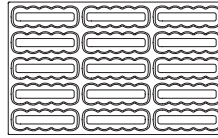

DS02

mm 90x30x19 h
~ 38 ml
15 impronte / indents

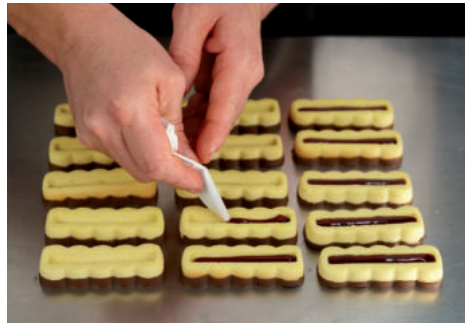

Chocoflex

Stampi in silicone per creazioni dolci o salate. Ideali per realizzare grandi quantità in poco tempo. Gli stampi possono essere utilizzati in forno, in frigorifero e abbattitore. Resistono a temperature da -40°C a + 250°C. / Silicone moulds for sweet or savoury creations. Ideal for making large quantities in a short time. They can be used in ovens, refrigerators and blast chillers. They can withstand temperatures from -40°C to +250°C.

Dimensione stampo /
Mould size: mm 290×190

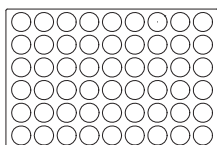

LS01

Ø mm 26×14 h
~ 7,5 ml
54 impronte / indents

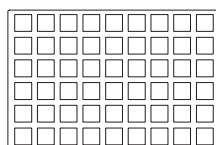

LS02

mm 23×23×14 h
~ 7,5 ml
54 impronte / indents

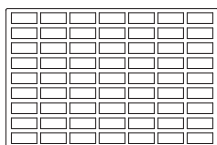

LS03

mm 35×14×14 h
~ 7,5 ml
63 impronte / indents

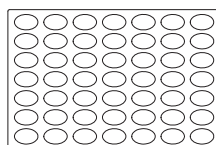

LS04

mm 32×21×14 h
~ 7,5 ml
49 impronte / indents

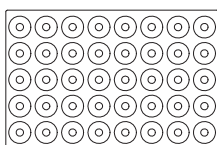

LS06

Ø esterno / external
mm 30
Ø interno / internal
mm 10
h 12 mm / ~ 7,5 ml
40 impronte / indents

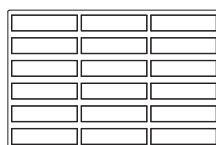

LS07

mm 90×22×10 h
~ 19,5 ml
18 impronte / indents

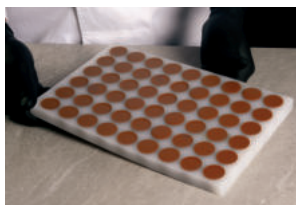

Colori e
materie prime
*Colours &
raw materials*



Colori in Spray

Spray colours

Spray effetto velluto
 "Dolce Velluto" 400 ml
 Velvet effect spray
 "Dolce Velluto" 400 ml



E171 free



100%
AZO FREE

*Colori AZO free
AZO free colours



Spray al burro di cacao colorato, da applicare su superfici fredde per ottenere l'effetto velluto. / Coloured cocoa butter spray to be applied on cold surfaces to achieve the velvet effect.



DV1SB
rosso
red



DV2SB
arancione
orange



DV3SB*
giallo
yellow



DV4SB
rosa
pink



DV5SB*
marrone scuro
dark brown



DV6SB
marrone chiaro
light brown



DV7SB*
bianco
white



DV8SB
verde
green



DV9SB*
azzurro
sky blue



DV12SB
amarena
black cherry



DV14SB
nero
black



DV15SB
blu tiffany
tiffany blue







DV17SB*
oro
gold

Spray perlescente 250 ml Pearl effect spray 250 ml



Base alcolica, per decorazione dolci, cioccolato e pasta di zucchero. / Alcohol based, for cake decoration, chocolate and sugar paste.

	SM10SB oro gold		SM13SB argento silver
	SM11SB bronzo bronze		SM12SB rubino ruby

Spray pastello 250 ml Pastel spray 250 ml



*Colori AZO free
AZO free colours



Base acquosa, pronti all'uso per decorazione torte a base di panna e cioccolato, biscotti, wafer e cialde a base di pasta di zucchero. / Water based, ready to use, ideal to decorate creams and chocolate cakes, biscuits, wafers and sugar paste wafers.

	SP01250SB rosso red		SP05250SB* blu blue
	SP02250SB* rosa pink		SP07250SB arancione orange
	SP03250SB marrone brown		SP08250SB* verde green
	SP04250SB giallo yellow		

Colori in polvere

Powder colours

Idrosolubile in polvere
"Absolute" 50 g
Water soluble powder
"Absolute" 50 g



E171 free

100%
AZO FREE*Colori AZO free
AZO free colours

Alta densità di colore, per zucchero artistico, macaron, pasta di zucchero e ghiaccia. / High colour density, for artistic sugar, macarons, sugar paste and icing.
(by Emmanuele Forcone)

	A01SB rosso ciliegia cherry red		A07SB viola purple
	A02SB arancione orange		A08SB rosa pink
	A03SB giallo limone lemon yellow		A09SB marrone brown
	A04SB verde mela apple green		A10SB nero black
	A05SB verde green		A11SB rosso vivo bright red
	A06SB* blu blue		

Liposolubile in polvere
"Chocolart" 40 g
Fat soluble powder
"Chocolart" 40 g



E171 free



100%
AZO FREE

*Colori AZO free
AZO free colours



Alta densità di colore, da sciogliere nel burro
di cacao. /
High colour density to melt in cocoa butter
products.

(by Emmanuele Forcone)

	L01SB* verde mela apple green		L07SB* nero black
	L02SB* verde green		L08SB* bianco white
	L03SB* blu blue		L09SB rosa pink
	L04SB* giallo limone lemon yellow		L10SB rosso red
	L05SB giallo uovo egg yellow		L11SB* lilla lilac
	L06SB arancione orange		L12SB* blu tiffany tiffany blue

Colori in polvere

Powder colours

Perlescente in polvere
"Brilliant" 40 g
Metallized powder
"Brilliant" 40 g



E171 free

100%
AZO FREE

Effetto perlescente per lavorazioni in cioccolato, zucchero e pastigliaggio. Solubili in alcol o utilizzabili allo stato puro. /

Pearlescent effect for your chocolate, sugar and pastillage creations. Soluble in alcohol or usable in purity.

(by Emmanuele Forcone)



M01SB
oro
gold



M02SB
argento
silver



M03SB
rubino
ruby



M04SB
bronzo
bronze



M07SB
rame
copper



M08SB
viola
purple

Polvere perlescente spray
"Stardust" 10 g
Spray pump powder
"Stardust" 10 g



E171 free

100%
AZO FREE

Fine polvere perlescente con pompetta ad aria per decorare prodotti finiti. /

Thin pearlescent powder with air pump for decorating finished products.



S01SB
rubino
ruby



S02SB
oro
gold



S03SB
argento
silver



S04SB
bronzo
bronze

Colori al burro di cacao *Cocoa butter colours*

Burro di cacao
"Chocolart" 200 g
Cocoa butter
"Chocolart" 200 g



E171 free



100%
AZO FREE

*Colori AZO free
AZO free colours



Colori pronti all'uso. Ideali per colorare
cioccolato in massa, in superficie e in stampo.
/ Ready to use colours. Ideal for colouring
chocolate, surface and mould.

(by Emmanuele Forcone)

	LB01SB* verde mela apple green		LB08SB* bianco white
	LB02SB* verde green		LB09SB rosa pink
	LB03SB* blu blue		LB10SB rosso red
	LB04SB* giallo limone lemon yellow		LB11SB* lilla lilac
	LB05SB giallo uovo egg yellow		LB12SB* oro gold
	LB06SB arancione orange		LB14SB* bronzo bronze
	LB07SB* nero black		LB15SB* rubino ruby

Colori liquidi

Liquid colours

Liposolubile liquido 180 g

Fat soluble liquid 180 g



E171 free

100%
AZO FREE*Colori AZO free
AZO free colours

Ideali per la colorazione di masse di cioccolato e di tutte le masse grasse. / Suitable to colour mass of chocolate and all fat masses.



LL01SB
verde
green



LL02SB
giallo uovo
egg yellow



LL07SB
rosso
red



LL08SB*
blu
blue



LL10SB*
nero
black



LL11SB
giallo limone
lemon yellow

Idrosolubile liquido 190 ml

Water-soluble liquid 190 ml



E171 free

100%
AZO FREE*Colori AZO free
AZO free colours

Colori idrosolubili a base di acqua per aerografo. / Water-soluble colours for airbrush.



CLN01SB
verde
green



CLN02SB
giallo uovo
egg yellow



CLN04SB
viola
purple



CLN05SB
marrone
brown



CLN06SB*
azzurro
sky blue



CLN07SB
rosso
red



CLN08SB*
blu
blue



CLN09SB
rosa
pink



CLN10SB
nero
black



CLN11SB
giallo limone
lemon yellow



Concentrati naturali

Natural extract

Concentrati naturali a base burro di cacao "Seasons" 200 g
Cocoa butter natural concentrates "Seasons" 200 g



E171 free

100%
AZO FREE

Seasons è la gamma di concentrati vegetali a base burro di cacao per la colorazione di masse di cioccolato, per l'applicazione diretta, oppure all'interno di glasse o finiture ad effetto velluto. Vegan friendly. / Seasons is the range of cocoa butter with vegetable concentrates for colouring chocolate masses, for direct application, for glazes or velvet effect finishing. Vegan friendly.

	NC01 verde mela apple green		NC07 viola purple
	NC02 verde green		NC08 fondente dark brown
	NC03 azzurro light blue		NC09 rosa pink
	NC04 giallo yellow		NC10 rosso red
	NC05 rosso ciliegia cherry red		NC11 marrone latte milk cocoa
	NC06 arancione orange		

Concentrati naturali in polvere
 "Seasons" 80 g
 Powdered natural concentrates
 "Seasons" 80 g



E171 free



100%
AZO FREE



Seasons aggiunge un tocco in più alle tue preparazioni. Glasse, impasti, creme, farciture, frolle, viennoiserie: sono solo alcuni degli usi possibili di Seasons. Concentrati vegetali a base di alga spirulina, zucca, barbabietola e molti altri. /

Seasons adds an extra touch to your preparations. Icing, doughs, creams, fillings, shortcrust pastry, viennoiserie: these are just some of Seasons many uses. Plant extracts based of spirulina algae, pumpkin, beetroot and many others.



NCP01
verde mela
apple green



NCP06
arancione
orange



NCP02
verde
green



NCP07
viola
purple



NCP03
verde
green



NCP08
fondente
dark brown



NCP04
giallo
yellow



NCP09
rosa
pink



NCP05
rosso ciliegia
cherry red



NCP10
rosso
red

Decorazioni

Decorations

Pepite perlescenti di cioccolato 120 g Pearly chocolate grains 120 g



E171 free

100%
AZO FREE

Pepite di cioccolato dall'effetto perlescente per la decorazione di soggetti in cioccolato. / Chocolate grains with a pearlescent effect to decorate your chocolate creations.



PT01SB
rame
copper



PT04SB
bronzo
bronze



PT02SB
rubino
ruby



PT05SB
marrone
brown



PT03SB
oro
gold

Perle di zucchero 120 g Sugar pearls 120 g



E171 free

100%
AZO FREE

ZP01SB
oro
gold
Ø 4 mm



ZP05SB
blu metallizzato
metallized blue
Ø 4 mm



ZP02SB
argento
silver
Ø 4 mm



ZP06SB
oro
gold
Ø 6 mm



ZP03SB
rosa metallizzato
metallized pink
Ø 4 mm



ZP07SB
argento
silver
Ø 6 mm



ZP04SB
verde metallizzato
metallized green
Ø 4 mm



sup
JUBAE



pa
Pearl
Dipit

100 g
212 kJ
501 kcal
27 g
16 g
53 g

Decorazioni *Decorations*

Scaglie 1 g
Flakes 1 g



OROSC1
oro
gold



ARGENTOSC1
argento
silver

Polvere 0,5 g
Powder 0,5 g



OROPV
oro
gold



ARGENTOPV
argento
silver

Fogli
Sheets



ORO
oro
gold



ARGENTO
argento
silver

0,35 g
80×80 mm
25 fogli - sheets

Easydecor 1 kg



Pasta di zucchero, aromatizzata alla vaniglia, adatta a coperture e modellaggio in piano o tridimensionale, aggiungendo zucchero a velo. Pronta all'uso. Disponibile in vari colori, si può anche colorare con idrosolubili Pavoni Italia. / Sugar paste lightly flavoured with vanilla. It is suitable for cake covering and flat modeling (for three-dimensional modeling is sufficient to harden the dough by adding sugar). Ready to use. Available in various colours, it can be also coloured with water-soluble colours.

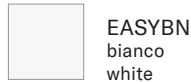

EASYBN
bianco
white



EASYR
rosso
red



EASYN
nero
black



EASYBL
blu
blue



EASYAZ
azzurro
light blue

Decotab 6 kg



Decotab è ideale per la copertura di torte e per la realizzazione di soggetti e decorazioni. Decotab ha un leggero aroma di mandorla e può essere colorato utilizzando i colori idrosolubili. /

Decotab can be used to cover cakes and create subjects and decorations. Decotab is white coloured with an almond hint; it can be also coloured with the water-soluble food colours.



DECOTAB
bianco
white

Decorazioni

Decorations

Decotab colours

250 g e 1 kg



Realizzate con la stessa ricetta di Decotab, le paste di zucchero Decotab colours offrono molteplici possibilità decorative con un notevole risparmio di tempo e grande omogeneità di colore. / Made with the same recipe for Decotab, the Decotab coloured sugar pastes offer many decorative opportunities with remarkable time-saving and a perfect colour homogeneity.

Decotab colours 1 kg

	DECOTABRC rosa naturale light rose		DECOTABCO marrone brown		DECOTABN nero black		DECOTABAZ azzurro light blue
	DECOTABBN bianco white		DECOTABVC verde chiaro light green		DECOTABR rosso red		DECOTABG giallo brillante bright
	DECOTABRA rosa pink		DECOTABFU fucsia fuchsia		DECOTABBL blu blue		DECOTABVS verde green

Decotab colours 250 g

	DTAR250 arancio orange		DTR250 rosso red		DTVS250 verde scuro dark green		DTBN250 bianco white
	DTAZ250 azzurro light blue		DTGU250 giallo uovo egg yellow		DTVC250 verde chiaro light green		DTCO250 marrone brown
	DTRA250 rosa pink		DTG250 giallo brillante bright yellow		DTN250 nero black		DTVL250 viola purple
	DTGL250 glicine wisteria		DTFU250 fucsia fuchsia		DTBL250 blu blue		DTRC250 rosa naturale light rose

Pastamica 5 kg



Pasta di zucchero bianca e malleabile per copertura. Aromatizzata alla vaniglia. Facile da stendere, per una copertura perfetta, senza crepe e bolle. /

Elastic and white sugar paste for covering. It has a light vanilla hint. Easy to spread, it creates a perfect covering, without breaks and bubbles.

Code

PASTAMICA

Decorazioni

Decorations

Massa Pavoni Summer 5 kg



Pasta di zucchero bianca ed elastica, adatta per copertura. Non teme l'umidità e gli sbalzi di temperatura. Non crea condensa superficiale una volta estratta la torta dal frigo. Aroma vanigliato. Colore bianco. / Elastic and perfect for covering, it has a soft vanilla taste. It resists at humidity and hot temperature, it does not create surface condense once the cake gets out from refrigerator. Pure white colour.

Code

MASSAPAVONISUMMER

Ciocoplast 6 kg



Cioccolato plastico per modellaggio ideale per la creazione di soggetti, fiori e nastri. L'estrema malleabilità lo rende adatto anche a coperture. Non si attacca alle mani, rimane morbido per giorni e ha un gradevole sapore di cioccolato. Disponibile nei colori bianco e marrone. / The plastic chocolate is the ideal product for the creation of flowers and ribbons, thanks to its consistency. The extreme malleability and plasticity of this product make it suitable to cover cakes too. Ciocoplast does not stick to hands, remains soft for days and has a pleasant chocolate taste. Available in white and brown colours.



CIOCOPLASTBN
bianco
white



CIOCOPLASTMR
marrone
brown

Ciocoplast colours 1 kg e 250 g



Ciocoplast colours è una gamma di colori vividi e intensi per decorare soggetti e preparazioni, con un notevole risparmio di tempo e grande omogeneità di risultato. /

Ciocoplast colours offer a range of intense colours to decorate cakes with considerable time-saving and great colour uniformity.

Ciocoplast colours 1 kg



Ciocoplast colours 250 g



CPAZ250
azzurro
light blue



CPBN250
bianco
white



CPCO250
marrone
brown



CPG250
giallo
yellow



CPGL250
glicine
wisteria



CPN250
nero
black



CPRA250
rosa
pink



CPR250
rosso
red



CPVC250
verde chiaro
light green



CPVS250
verde scuro
dark green



CPVL250
viola
purple

Isomalto per zucchero artistico Isomalto for artistic sugar



Code	Peso / Weight (g)
ISOPAV500	500
ISOMALTOKG1	1000
ISOMALTOKG5	5000
ISOMALTO	2500

Real ghiaccia 3 kg



Prodotto in polvere che sostituisce la ghiaccia reale, migliorandone le prestazioni, miscelabile in acqua e subito pronto all'uso. Può essere applicato direttamente sulla torta mediante sac à poche, creando finissime decorazioni. Rispetto alla tradizionale ghiaccia, mantiene la sua elasticità nel tempo. /
Realghiaccia is a powdered product that replaces real icing and improves its performances. Ready to use after mixing with water. You can decorate your cakes with fine decorations by using it directly with a piping bag. Compared to traditional royal icing, Real ghiaccia maintains its elasticity as time goes by.

Code
REALGHIACCIA

Mix Macaron 500 g



Preparato per la realizzazione di macarons. Ideale da usare con i nostri tappetini per macaron. / Powder mix to create macarons. It can be used with our macaron mats.



MACARONBN
bianco
white



MACARONRA
rosa
pink

Chocoice 400 ml



Refrigerante spray per zucchero e cioccolato. / Chocolate and sugar spray cooler.

Code

CHOCOICE



Brillspray 400 ml



Lucidante spray per cioccolato, zucchero e marzapane. / Chocolate, sugar and marzipan spray glazing.

Code

BRILLSPRAY



Decorazioni Decorations

Magic Decor



Preparato in polvere, da utilizzare in abbinamento ai tappetini in silicone per decorazioni, per la creazione di pizzi in zucchero. /

Magic Decor is a powder mix you can use on our silicone mats for decorations to create amazing sugar laces.

Code	Peso / Weight (g)
MAGICDECOR250	250
MAGICDECOR	500
MAGICDECOR3	3000

Strisce in silicone Stripe silicone mats



SMD03*
mm
390x80,5 h

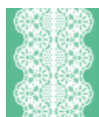

SMD04A*
mm
390x80,5 h

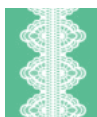

SMD04B*
mm
390x80,5 h



SMD05*
mm
390x80,5 h



SMD07A*
mm
390x80,5 h



SMD07B*
mm
390x80,5 h



SMD08*
mm
390x80,5 h



SMD09*
mm
390x80,5 h



SMD10*
mm
390x80,5 h



SMD11*
mm
390x80,5 h



SMD102*
mm
368x135 h



SMD100*
mm
368x135 h



TMD05*
mm
400x300 h



TMD02*
mm
400x300 h



TMD04*
mm
400x300 h



TMD06*
mm
400x300 h



TM D08*
mm
400x300 h

*fino a esaurimento
until exhaustion

Materie prime

Raw materials

Agar Agar 250 g

Per gelificare creme e liquidi. Vegetale, naturale, agente gelificante solubile al caldo. L'effetto gel si ottiene quando si raffredda. Sostituto della gelatina per dolci, pasticcini, dessert. La soluzione agar agar deve essere prima portata a ebollizione. /

To gel creams and fluids. Vegetable, natural, heat-soluble gelling agent. The gel is obtained when cooled. Substitute of gelatine in confectionery, pastry, desserts. The agar agar solution must first be brought to the boil.

Zucchero invertito

Inverted Sugar 250 g

Utile per abbassare il punto di congelamento e mantenere umidi i prodotti da forno. Capace di mantenere l'umidità meglio del saccarosio: aumenta la morbidezza donando un gusto dolce più intenso. /

To lower the freezing point and retain moisture of baked products. Able to retain moisture better than saccharose: improves softness with a more significant sweet taste.

Hyfoama 250 g

Per montare soluzioni zuccherine calde e fredde. Per sostituire l'albume per ghiacce e meringhe. /

To whip hot and cold sugar solutions. To substitute the egg white for icing and meringue.

Gomma xanthano

xanthan gum 250 g

Utile a stabilizzare e addensare impasti privi di glutine o ispessire le salse. /
To stabilize and thicken gluten free dough.
To thicken sauces.

Sciroppo di glucosio

Glucose syrup 250 g

Previene la congelazione di gelati e mousse e la cristallizzazione di praline e prodotti in cioccolato. Utile per preparare pasta di zucchero e cioccolato plastico. /

To prevent freezing of ice cream and mousse. To prevent crystallization of pralines and other chocolate products. To prepare sugar paste and plastic chocolate.

Pectina

Pectin 1 Kg

Impiegata per gelificazione di gelatine di frutta. /

Used to gelatinize fruit jellies.

Sali Di Silicio

Silicon Salts 1 Kg

Protegge dall'umidità le composizioni artistiche in zucchero colato e cioccolato. /
To protect cast sugar and chocolate compositions from humidity.

Attrezzature
Equipment



FOROSIL



Stampi monouso

Disposable moulds

Stampi monouso ideali per realizzare semifreddi e dessert in diverse forme e misure. Vantaggi:

- riduzione dei tempi di preparazione
- riduzione dei tempi di raffreddamento
- lavoro organizzato e veloce
- massima igiene
- risparmio di acqua e detersivi inquinanti
- riciclo del prodotto al 100% nella filiera della plastica
- stoccaggio razionalizzato, risparmio di spazio ed eliminazione dell'uso della pellicola protettiva
- linguetta extra-grip per uno smodellaggio semplice e veloce

Disposable moulds ideal for making parfaits and desserts in different shapes and sizes. Benefits:

- reduced preparation time
- reduced cooling time
- organised and fast work
- maximum hygiene
- saving of water and polluting detergents
- 100% product recycling in the plastic chain
- rationalised storage, space-saving and elimination of the use of protective foil
- extra-grip tear strip for quick and easy demoulding

Voilà tondi per torte e inserimenti Round Voilà for cakes and inserts

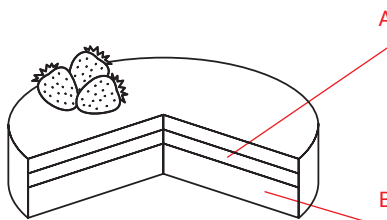

A. stampi monouso Voilà per inserimenti /
Voilà disposable moulds for inserts



B. stampi monouso Voilà per la creazione di torte con raggio stondato /
Voilà disposable moulds to create round rimmed cakes

VL240

Ø mm 240×40 h
100 pcs per confezione
100 pcs per box

abbinabile con inserimento
can be combined with insert:

IN220

Ø mm 220×10 h
220 pcs per confezione
220 pcs per box

VL180

Ø mm 180×40 h
225 pcs per confezione
225 pcs per box

abbinabile con inserimento
can be combined with insert:

IN160

Ø mm 160×10 h
450 pcs per confezione
450 pcs per box

VL220

Ø mm 220×40 h
100 pcs per confezione
100 pcs per box

abbinabile con inserimento
can be combined with insert:

IN200

Ø mm 200×10 h
300 pcs per confezione
300 pcs per box

VL160

Ø mm 160×40 h
300 pcs per confezione
300 pcs per box

abbinabile con inserimento
can be combined with insert:

IN140

Ø mm 140×10 h
600 pcs per confezione
600 pcs per box

VL200

Ø mm 200×40 h
150 pcs per confezione
150 pcs per box

abbinabile con inserimento
can be combined with insert:

IN180

Ø mm 180×10 h
400 pcs per confezione
400 pcs per box

VL140

Ø mm 140×40 h
300 pcs per confezione
300 pcs per box

VL120

Ø mm 120×40 h
300 pcs per confezione
300 pcs per box

Voilà per monoporzioni Voilà for single-serving portions

VL65

Ø mm 65×40 h
900 pcs per confezione
900 pcs per box

Voilà quadrate per torte Square Voilà for cakes

VLQ140

mm 140×140×40 h
300 pcs per confezione
300 pcs per box

VLQ160

mm 160×160×40 h
300 pcs per confezione
300 pcs per box

VLQ180

mm 180×180×40 h
150 pcs per confezione
150 pcs per box

Voilà per quadri Voilà frames

VL6430

Dim. internal
mm 570×365×30 h
Dim. external
mm 590×390×30 h
30 pcs per confezione
30 pcs per box

VL6435

Dim. internal
mm 570×365×35 h
Dim. external
mm 590×390×35 h
30 pcs per confezione
30 pcs per box

VL6440

Dim. internal
mm 570×365×40 h
Dim. external
mm 590×390×40 h
30 pcs per confezione
30 pcs per box

VL4030

Dim. internal
mm 360×360×30 h
Dim. external
mm 390×390×30 h
50 pcs per confezione
50 pcs per box

VL4035

Dim. internal
mm 360×360×35 h
Dim. external
mm 390×390×35 h
50 pcs per confezione
50 pcs per box

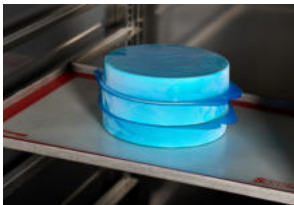



Tappetini in silicone

Silicone mats

Scopri tutta la gamma di tappetini antiaderenti in silicone in differenti misure e utilizzi.

Spv, la linea iconica di Pavoni Italia, indispensabile in ogni pasticceria, in silicone alimentare per cottura e surgelazione e Forosil, il microforato per le cotture ottimali di numerose preparazioni da forno.

Novità dedicate al mondo della ristorazione con innovativi tappetini con angoli stondati che sapranno adattarsi perfettamente alle teglie gastronomiche.

Discover the entire range of non-stick silicone mats; different sizes and uses.

Spv, the iconic line of Pavoni Italia, indispensable in every pastry shop, in food-grade silicone with multiple uses and Forosil, the micro-perforated mat for optimal cooking of different preparations.

New products dedicated to the world of catering and restaurant with innovative mats with rounded corners that will fit perfectly to gastronomic trays.

Tappetini Gastronorm Gastronorm Mats

Tappetini in silicone antiaderente con angoli arrotondati per teglie Gastronorm 1/1. /
Non-stick silicone mats with rounded corners for Gastronorm 1/1 trays.



SPVGASTRO 1/1

mm 475×275

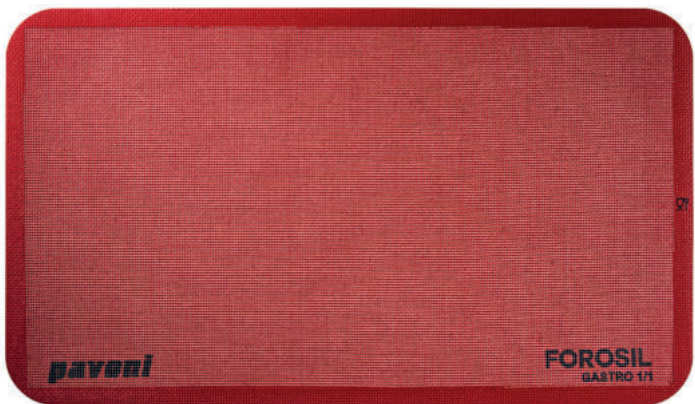

FOROSILGASTRO 1/1

mm 475×275

SPV

Tappetini antiaderenti in silicone adatti sia per cottura che surgelazione. Per utilizzo da -40°C a +250°C. /

Non-stick silicone mats suitable for baking and freezing. It can be used at temperatures from -40°C to +250°C.



Code	Dimension (mm)
SPV43	385×285
SPV53	520×315
SPV64	585×385
SPV86	790×590
SPV6242	620×420
SPV88	790×770

Code	Dimension (mm)	Ø Impronte indents (mm)
SPV64MACARONS	585×385	esterno / external 400 interno / internal 300



Forosil

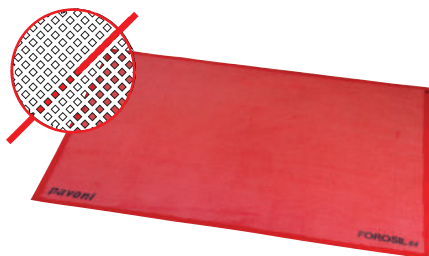

Forosil è il tappetino in silicone microforato perfettamente antiaderente. La presenza dei microfori facilita la distribuzione ottimale del calore. /

Forosil is a perfectly non-stick micro-perforated silicone mat. The micro-holes facilitate the optimal distribution of heat.

Code	Dimension (mm)
FOROSIL43	385×285
FOROSIL53	520×315
FOROSIL64	585×385

Forosil Éclair

Tappetini in silicone microforato e antiaderente, sagomati e progettati per la preparazione semplice e versatile di éclair. La distribuzione ottimale del calore è garantita dai microfori, che permettono all'impasto uno sviluppo in altezza e una perfetta cottura del prodotto. /

Micro-perforated and non-stick silicone mats, shaped and designed for the simple and versatile preparation of éclairs. The micro-perforations guarantee the optimal distribution of heat and allow optimal rising and the perfect baking of the product.

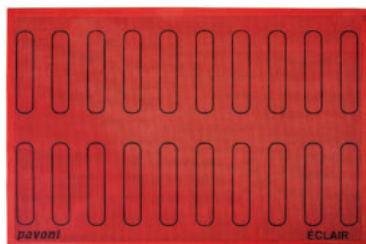

ECL20

mm 125×25
20 impronte / indents
Dim. stampo / mould mm 600×400

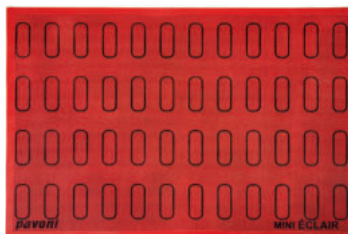

ECL48

mm 60×18
48 impronte / indents
Dim. stampo / mould mm 600×400

Forosil Strip

La praticità di Forosil, in formato striscia. Le Forosil Strip sono totalmente antiaderenti e la presenza dei microfori garantisce una migliore e più efficace distribuzione del calore. Utilizzatele per foderare le fasce piene in acciaio inox: otterrai torte perfette e dalla facile sformatura, senza la necessità di ungerle! Si prestano all'impiego con torte da forno e lievitate. Sviluppate in collaborazione con Stefano Laghi. / The convenience of Forosil comes in strip. The Forosil Strips are totally non-stick and the micro-holes guarantee a better and more effective heat distribution. Use them to line the smooth stainless steel bands: you'll get perfect cakes, easy to unmold, without greasing before! You can use them for cakes to bake and leavened preparations. Developed in cooperation with Stefano Laghi.



Code	Dimension (mm)	PCS per box
STRIP20FPC	635x18 h max	10
STRIP30FPC	635x28 h max	10
STRIP35FPC	635x33 h max	10
STRIP40FPC	635x38 h max	10

Abbinabile alle fasce lisce. /
Can be combined with the smooth bands.





Storage & Display

Una linea completa di prodotti per esporre e stoccare:

- Vassoietti in diverse forme, colori e misure; con una pratica impugnatura per servire e movimentare facilmente i prodotti
- Pack per il confezionamento di soggetti, barrette in cioccolato e macaron
- Covering: pratici coperchi inalterabili agli urti e abbinati ai vassoi per sovrapporre, stoccare e trasportare.

A complete range of products for displaying and storing:

- Trays in different shapes, colours and sizes; with a practical handle for easy serving and handling of products
- Plastic boxes for packing chocolate subjects, chocolate bars and macarons
- Covering: practical, impact-resistant lids combined with trays for stacking, storing and transporting your creations.

Vassoi per monoporzioni Single-serving trays

Vassoi per monoporzioni. Disponibili nei colori bianco, nero, trasparente e, a richiesta, anche personalizzati. /
Single-serving trays. Available in white, black and transparent colour, but also customized on demand.



VP1NR

mm 80×80

■ nero / black

Scatola da / Box of 250 pcs



VP1BN

mm 80×80

□ bianco / white

Scatola da / Box of 250 pcs



VP1T

mm 80×80

□ trasparente / transparent

Scatola da / Box of 250 pcs



VP2NR

mm 130×38

■ nero / black

Scatola da / Box of 250 pcs



VP2BN

mm 130×38

□ bianco / white

Scatola da / Box of 250 pcs



VP2T

mm 130×38

□ trasparente / transparent

Scatola da / Box of 250 pcs



VP3NR

Ø mm 80

■ nero / black

Scatola da / Box of 250 pcs



VP3BN

Ø mm 80

□ bianco / white

Scatola da / Box of 250 pcs



VP3T

Ø mm 80

□ trasparente / transparent

Scatola da / Box of 250 pcs

Vassoi per medie porzioni Medium portions trays

Vassoietti per medie porzioni, utilizzabili con la linea 40time. Disponibili nei colori bianco e nero. /
Medium portion trays. They can be used with the 40time line. Available in white and black colour.



VP4NR

mm 60×60

■ nero / black
Scatola da /
Box of 350 pcs



VP4BN

mm 60×60

□ bianco / white
Scatola da /
Box of 350 pcs



VP5NR

mm 90×38

■ nero / black
Scatola da /
Box of 350 pcs



VP5BN

mm 90×38

□ bianco / white
Scatola da /
Box of 350 pcs



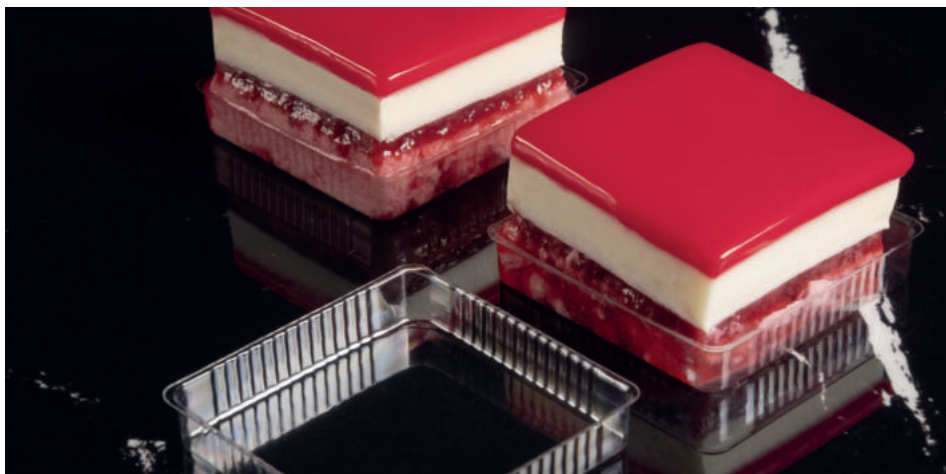

Vassoietti per miniporzioni Trays for mini-portions

Per spostare, servire e presentare al meglio le tue miniporzioni. In materiale compostabile e trasparente, resistente all'umidità e perfetti per essere presi con pinze o con le mani. / To move, serve and present your mini-portion preparations. They are made of compostable material, totally transparent, resistant to humidity, and non-deformable: perfect for gripping with tongs or by hand.



VM4B

mm 35×35×8 h
quadrato / square
Scatola da 2400 pz /
Box of 2400 pcs

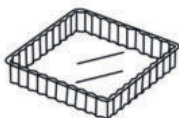

VM2B

mm 42×42×8 h
quadrato / square
Scatola da 2000 pz /
Box of 2000 pcs

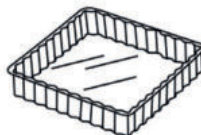

VM1B

Ø mm 42×8 h
tondo / round
Scatola da 2000 pz /
Box of 2000 pcs

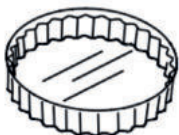

VM3B

mm 62×26×8 h
rettangolare / rectangular
Scatola da 2000 pz /
Box of 2000 pcs

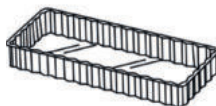

Altri vassoietti Trays



VC1

mm 140×40
oro / gold
Scatola da /
Box of 200 pcs

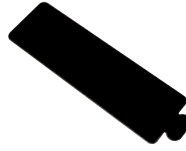

VC2

mm 140×40
nero / black
Scatola da /
Box of 200 pcs

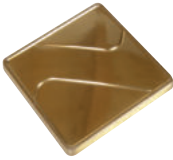

VC4

mm 85×85×7 h
oro / gold
Scatola da /
Box of 250 pcs

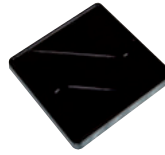

VC5

mm 85×85×7 h
nero / black
Scatola da /
Box of 250 pcs

Scatole Packaging



KS50
Confezione per tavolette
Choco bar pack

mm 156×80×15 h
100% riciclabile nella
filiera della plastica /
100% recyclable in the
plastic supply chain
20 pezzi per confezione /
20 pcs per box



KS51
Confezione per tavoletta
maxi
Maxi Choco bar pack

mm 255×155×28 h
100% riciclabile nella
filiera della plastica /
100% recyclable in the
plastic supply chain
5 pezzi per confezione /
5 pcs per box



KS26

mm 162×131×206 h
100% riciclabile nella
filiera della plastica /
100% recyclable in the
plastic supply chain
20 pezzi per confezione /
20 pcs per box

KS32

mm 160×160×220 h
100% riciclabile nella
filiera della plastica /
100% recyclable in the
plastic supply chain
2 pezzi per confezione /
12 pcs per box



Macaron Display

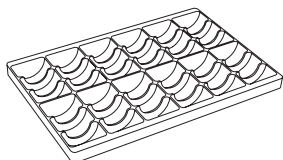

MC36 Macaron Display

mm 295×195
36 impronte / indents
dim impronte / indents Ø mm 48x25
100% riciclabile nella filiera della plastica /
100% recyclable in the plastic supply chain
200 pezzi per confezione / 200 pcs per box

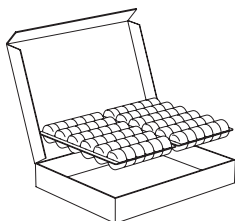

SMC72

internal dim mm 385×295×60 h
scatola in cartone / carton box
può contenere 2 coppie MC36 /
it may contain 2 couples MC36
20 pezzi per confezione / 20 pcs per box

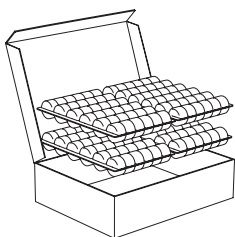

SMC144

internal dim mm 385×295×100 h
scatola in cartone / carton box
può contenere 4 coppie MC36 /
it may contain 4 couples MC36
20 pezzi per confezione / 20 pcs per box

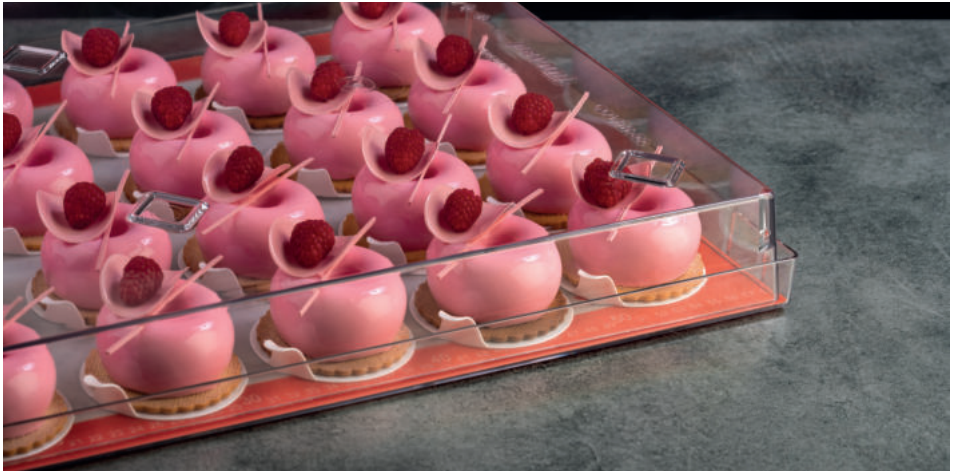

Covering

Plus:

- Inalterabile agli urti e alle basse temperature
- Sovrapponibile e inseribile
- Massima trasparenza
- Evita la condensa durante lo stoccaggio in frigoriferi e abbattitori
- Disponibile in 2 altezze
- Abbinabile al vassoio Tray e alle teglie 600×400

Plus:

- Impact- and high-temperature resistant
- Stackable and insertable
- Maximum transparency
- Resists condensation during storage in refrigerators and blast chillers
- Available in 2 heights
- Can be combined with Tray and 600×400 trays

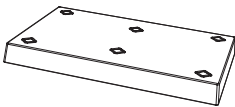

COVER55

Coperchio / lid
mm 585×390×55 h

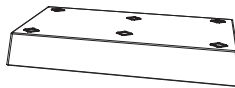

COVER85

Coperchio / lid
mm 585×390×85 h

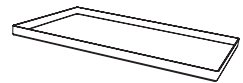

TRAY

Vassoio / tray
mm 590×395×28 h



Tools

Attrezzature ed accessori indispensabili. Spatole, teglie, sac a poche, girapanettoni e molto altro per supportare ogni professionista in ogni produzione e in ogni momento dell'anno.

Essential equipment and accessories. Spatulas, baking trays, piping bags and much more to support every professional in every production and at every moment of the year.

Gira panettoni "Gira Tu" Turn panettoni "Gira Tu"

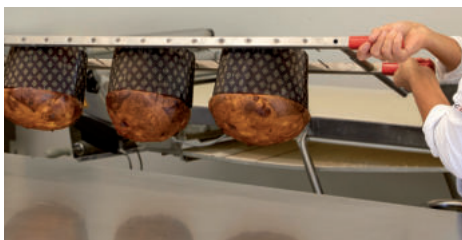

Facile da impilare su carrelli e rastrelliere. Realizzato in acciaio inox AISI 304 con impugnatura ergonomica. / Easy to stack on trolleys and racks, it's made of AISI 304 stainless steel and has an ergonomic handle.

Code	Dimension (mm)
GIRATU150	1500
GIRATU200	2000
GIRATU225	2250

Carrello per gira panettoni Turn panettoni trolley



Carrello in acciaio inox a 6 piani, 12 posizioni, per gira panettoni da 1,50/2,00/2,25 metri. Totalmente smontabile per un notevole risparmio di spazio in caso di non utilizzo. / Stainless steel trolley with 6 levels and 12 rails for panettoni; 1.50/2.00/2.25 meters. The trolley can be fully disassembled to save space when not used.

Code	Dimension (cm)	Distanza piani / level spacing (cm)
CARGP150	132×66×190 h	27
CARGP200	182×66×190 h	27
CARGP225	207×66×190 h	27

Realizzabile anche con dimensioni su richiesta. / Dimensions customizable on request.

Tools

Gira panettoni Giro lo Turn panettoni Giro lo

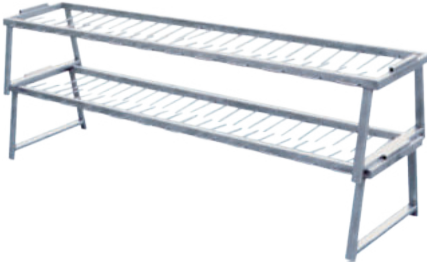

Gira panettoni sovrapponibile ideato per risolvere i problemi di spazio nei laboratori, agganciando contemporaneamente diverse pezzature di panettoni, colombe, veneziane etc. Può essere utilizzato da una sola persona, senza alcun aiuto, riuscendo a sovrapporre più telai fino a 150 kg di panettoni. Realizzato in acciaio inox. /

Stackable and space-saver Gira panettoni. It allows to hang many panettoni, colombe and veneziane. It requires just one person. It can stack many trays, till 150 kg of panettoni. Made of stainless steel.

Code	Dimension (mm)
------	----------------

GIROIO P	1650×380
----------	----------

GIROIO G	2150×380
----------	----------



Fruste Whisks



Attrezzature / Equipment

Fruste in acciaio inox indeformabile. Manico isolante resistente fino a 220°C. / Whips made of non-deformable stainless steel. Insulated handle resistant up to 220°C.

Code	Lunghezza length (mm)	Lunghezza manico / handle length (mm)
FT250FPC	250	105
FT350FPC	350	135
FT450FPC	450	205

Spatole e cucchiai Spatulas and spoons



Appiglio "hang on" per un comodo appoggio durante le lavorazioni, incavo pulisci bordi e manico extra grip. La giunzione tra paletta e manico è senza fessure per garantire massima igiene. /

"Hang on" handle for comfortable support while working, edge-cleaning recess and extra grip handle. The joint between paddle and handle is gapless for maximum hygiene.

Code	Lunghezza length (mm)	Lunghezza manico / handle length (mm)
SP300FPC	360	250
SP301FPC	260	170

Code	Lunghezza length (mm)	Lunghezza manico / handle length (mm)
SP302FPC	380	250
SP303FPC	270	170



RT
 Sac à poche monouso trasparente
 Transparent disposable piping bags



Code	Dimension (mm)	Spessore thickness (μm)	Pcs per box
RT40S	400	72	100
RT55S	550	72	100
RT65S	650	72	100

Powerflex

Sac à poche multiuso

Multi-use piping bags

- In resistente gomma alimentare
 - Non trasuda ed è perfettamente saldato
 - Facile da pulire, anche in lavastoviglie
 - Non assorbe gli odori
 - Ottimo grip antiscivolo
 - Adatto ai composti duri
 - Il foro che ospita la bocchetta non si deforma
- Made of durable food-grade rubber
 - Does not ooze and is perfectly welded
 - Easy to clean, even in the dishwasher
 - Does not absorb odours
 - Excellent non-slip grip
 - Suitable for hard compounds
 - The hole which houses the nozzle does not deform



Code	Lunghezza length (mm)	Pcs per box
PW040	400	1
PW045	550	1
PW050	650	1



Sac à poche multiuso Multi-use piping bags



Tools

Sac à poche multiuso in tela plastificata comodo e resistente senza cuciture, provvisto di asola. /

Made of plastic canvas and seamless; it is provided with tip hole.

Code	Lunghezza length (mm)	Pcs per box
14010	280	1
14020	340	1
14030	400	1
14040	460	1
14050	500	1
14060	550	1
14070	600	1
14080	650	1
14090	700	1







Porta sac à poche Piping bag holder









Code	Ø (mm)	Altezza height (mm)
34013	195	230

Bocchette in acciaio



Stainless steel piping tips

Tonda Round	Code	Ø (mm)	Altezza Height (mm)	Code	Ø (mm)	Altezza Height (mm)
 	125/2	2	43	125/12	12	43
	125/4	4	43	125/14	14	43
	125/6	6	43	125/16	16	43
	125/8	8	43	125/18	18	43
	125/10	10	43	125/20	20	43
Stella punta fine Small star	Code	Ø (mm)	Altezza Height (mm)	Code	Ø (mm)	Altezza Height (mm)
 	126/2	2	52	126/12	12	52
	126/4	4	52	126/14	14	52
	126/6	6	52	126/16	16	52
	126/8	8	52	126/18	18	52
	126/10	10	52	126/20	20	52
Stella punta larga Large star	Code	Ø (mm)	Altezza Height (mm)	Code	Ø (mm)	Altezza Height (mm)
 	127/2	2	52	127/12	12	52
	127/4	4	52	127/14	14	52
	127/6	6	52	127/16	16	52
	127/8	8	52	127/18	18	52
	127/10	10	52	127/20	20	52

Tools

Fiore Flower				Tools		
	Code	Ø (mm)	Altezza Height (mm)	Code	Ø (mm)	Altezza Height (mm)
	128/2	2	52	128/12	12	52
	128/4	4	52	128/14	14	52
	128/6	6	52	128/16	16	52
	128/8	8	52	128/18	18	52
	128/10	10	52	128/20	20	52
						
Delizia Delizia						
	Code	Ø (mm)	Altezza Height (mm)	Code	Ø (mm)	Altezza Height (mm)
	131/10	10	52	131/18	18	52
	131/12	12	52	131/20	20	52
	131/14	14	52	131/22	22	52
	131/16	16	52			
						
St. Honoré St. Honoré						
	Code	Ø (mm)	Altezza Height (mm)	Code	Ø (mm)	Altezza Height (mm)
	133/20	20	50	133/35	35	50
	133/25	25	50	133/40	40	50
	133/30	30	50			
						

Stampo per cannoli in banda stagnata Tin plate "Cannoli" mould

	Code	Dim. (mm)	Ø (mm)		Code	Dim. (mm)	Ø (mm)
	41A	120	30		40A	130	20
41B	140	35	40B	180	12		
41C	160	40	40C	290	27		

Bocchette in policarbonato Polycarbonate piping tips



Le dimensioni indicate fanno riferimento al diametro del foro da cui esce la crema. / The dimensions indicated refer to the diameter of the hole from which the cream comes out.

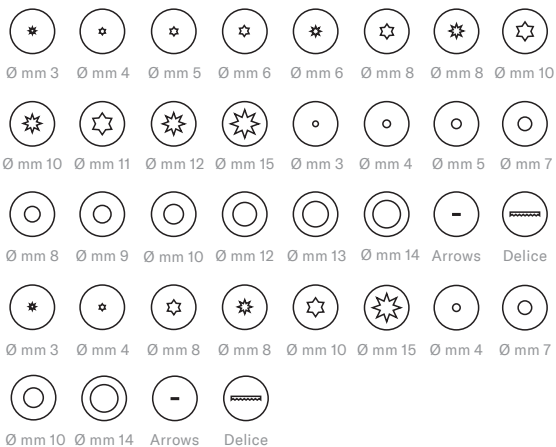

PB24

Kit 24 bocchette
Kit 24 piping tips
h bocchette /
h tips 55 mm



PB12

Kit 12 bocchette
Kit 12 piping tips
h bocchette /
h tips 55 mm

Griglia per il glassaggio Glazing grid



Griglia 600×400 mm. Misura compatibile con teglie, vassoi Covering e i tappetini SPV; con base rialzata per facilitare il processo di glassaggio. Realizzata in acciaio AISI 304, è resistente e semplice da pulire. / 600×400 mm grid for glazing. It perfectly fits trays, included the Covering range, and SPV mats. It has a raised base which allows to easily glaze your creations. Made of AISI 304 steel, it is resistant and easy to clean.

Code	Dimension (mm)
GLA64	600×400

Tools

Fogli chitarra Guitar sheets

Fogli per la creazione di decorazioni in cioccolato. Permettono di ottenere una finitura liscia e lucida e garantiscono il distacco immediato delle realizzazioni. Possono essere utilizzati anche per separare le preparazioni da stoccare in abbattitore, al fine di non far attaccare fra di loro i prodotti. / Sheets for creating chocolate decorations. They allow a smooth glossy finish and guarantee immediate detachment of creations. They can also be used to separate desserts to be stored in a blast chiller to prevent products from sticking.



Code	Dimension (mm)	spessore Thickness (µm)	Pcs per box
FCH34	390×390	100	100 (25 pcs risma / reams)
FCH64	590×390	100	100 (25 pcs risma / reams)

Materiale LDPE - LDPE Material

Fogli in PVC PVC sheets



Una perfetta barriera antiaderente per realizzare e sformare preparazioni dolci e semifreddi, utilizzando gli stampi e le sagome in acciaio. Ideale anche per la lavorazione del cioccolato e per realizzare originali decori. Non utilizzabili in cottura. / A perfect non-stick barrier designed to help make and remove desserts and semifreddo creations when using steel moulds and bands. Ideal also for working with chocolate and for creating original decorations. Not suitable for baking.

Code	Dimension (mm)	Spessore thickness (µm)	Pcs per box
FA64	600×400	100	100

Bobine in PVC PVC rolls



Bobina in PVC ad uso alimentare, ideale per rivestire i bordi degli stampi e delle sagome in metallo. Permette il facile distacco delle preparazioni dagli stampi senza rovinare i bordi. /

PVC roll for food use, ideal for covering the edges of moulds and metal shapes. It makes removal of the mixtures from the moulds easy without damaging the edges.

Code	Altezza height (mm)	Code	Altezza height (mm)
BB25	23	BB45	43
BB30	28	BB5	48
BB35	33	BB55	53
BB4	38	BB6	58

Lunghezza bobina 200 m / Reel length 200 m

Pavoflon



Ideale per cuocere gli impasti e per la produzione di pane precotto surgelato. Realizzato in teflon, mantiene nel tempo un'antiaderenza formidabile. Utilizzabile sia in forni elettrici che ventilati, oppure in tunnel, a temperature che vanno da -40°C a +350°C. Non è necessario ingrassare. Lavaggio in acqua tiepida con spugna morbida, senza detersivi abrasivi. /

Ideal for baking doughs and making pre-baked frozen bread. Made of Teflon, it maintains the non-stick surface over time. It can be used in both electric and ventilated ovens, or in tunnels, at temperatures ranging from -40°C to +350°C. No need to grease. Washing in warm water with a soft sponge, without abrasive detergents.





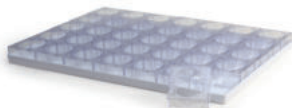

Code	Dimension (mm)
PVF0600400	600x400

Altri formati personalizzati sono disponibili su misura
Quantità min. di 20 fogli /
Customizable formats on request
Minimum quantity 20 sheets

Stampi in plastica per monoporzioni

Plastic moulds for single-serving portions













Code	Stampo mould	Stampo mould dim. (mm)	Stampi per vassoio / moulds per tray	Portion (g)	Vassoio tray dim. (mm)	Code estrattore demoulder	Code tagliapasta cutter
TTS		Ø 67×40 h	35	~75	600×400	ETS	CTS
TTS2			20		400×340		
TES		65×65×40 h	35	~75	600×400	EES	CES
TES2			20		400×340		
TTRS		76×69×40 h	35	~75	600×400		CTRS
TTRS2			20		400×340		
TCS		74×71×40 h	35	~75	600×400	ECS	CCS
TCS2			20		400×340		
TOS		86×55×40 h	35	~75	600×400	EOS	COS
TOS2			20		400×340		
TTNS		74×68×40 h	35	~75	600×400		CTNS
TTNS2			20		400×340		
TGS		90×58×40 h	35	~75	600×400	EGS	CGS
TGS2			20		400×340		
TVS		88×60×40 h	35	~75	600×400	EVS	CVS
TVS2			20		400×340		
TRS		76×51×40 h	35	~75	600×400	ERS	CRS
TRS2			20		400×340		
TQS		59×59×40 h	35	~75	600×400	EQS	CQS
TQS2			20		400×340		

Stampi in plastica per monoporzioni

Plastic moulds for single-serving portions



















Code	Stampo mould	Stampo mould dim. (mm)	Stampi per vassoio moulds per tray	Portion (g)	Vassoio tray dim. (mm)	Code estrattore demoulder	Code tagliapasta cutter
TMTS		Ø 44x25 h	96	~20	600x400	EMTS	CMTS
TMTS2			64		400x340		
TMES		42x42x25 h	96	~20	600x400	EMES	CMES
TMES2			64		400x340		
TMTRS		50x44x25 h	96	~20	600x400		CMTRS
TMTRS2			64		400x340		
TMCS		48x46x25 h	96	~20	600x400	EMCS	CMCS
TMCS2			64		400x340		
TMOS		55x35x25 h	96	~20	600x400	EMOS	CMOS
TMOS2			64		400x340		
TMTNS		47x44x25 h	96	~20	600x400	EMTNS	CMTNS
TMTNS2			64		400x340		
TMGS		60x38x25 h	96	~20	600x400	EMGS	CMGS
TMGS2			64		400x340		
TMVS		60x38x25 h	96	~20	600x400	EMVS	CMVS
TMVS2			64		400x340		
TMRS		51x31x25 h	96	~20	600x400	EMRS	CMRS
TMRS2			64		400x340		
TMQS		38x38x25 h	96	~20	600x400	EMQS	CMQS
TMQS2			64		400x340		











Placche per pastafrolla Plastic cutter grids



Ideali per biscotti, pizzette, salatini e basi per pasticcini, velocizzano il lavoro in laboratorio senza rinunciare alla fantasia. Disponibili in tante forme diverse. /

Suitable to prepare cookies, pizzas, savoury biscuits and pastry bases. Time-saving without any compromise with fantasy. Available in many shapes.

Code	Stampo mould	max dim. (mm)	n. Stampi N. Moulds
PF1		90	20
PF2		45	72
PF2A		40	95
PF3		53	53
PF3A		40	95
PF4		60	63
PF4A		40	95
PF5		45	60
PF5A		40	95
PF6		48	95
PF6A		40	116
PF7		48	78
PF7A		40	128
PF8		50	68
PF8A		40	105
PF9		80 66	50



Code	Stampo mould	max dim. (mm)	n. Stampi N. Moulds
PF10		60	36
PF10A		51	70
PF11		60	50
PF12		60	55
PF13		60 50	28 36
PF14		75 80	20 16
PF15		65 63	20 25
PF18		75 70	16 25
PF300	  	45 52 50 56 57	64



Chablon da forno 600×400 mm Baking chablon 600×400 mm



Realizzati in silicone, spessore 4 mm. Metti la teglia con lo chablon direttamente in forno, lo chablon non permetterà all'impasto di dilatarsi durante la cottura, producendo forme perfette. /

Silicone made, thickness 4 mm. Pour the mixture in the holes and level it, put the tray with the chablon in the oven and bake it. The chablon will not allow the product to expand and you will get perfect shapes.

Code	Stampo mould	Dim. (mm)	Impronte indents
CHT		Ø 35	96
CHQ		35×35	96

Code	Stampo mould	Dim. (mm)	Impronte indents
CHC		40×35	88
CHO		40×30	99

Stampi per pane Bread moulds



NIDODAPE

Nido d'ape
Honeycomb
mm 140x100

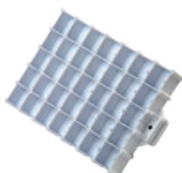

TARTARUGA

Tartaruga
Turtle
mm 140x100

Decora crostate Tarts decorator



DCR

Ø mm 300

Raschietti Scrapers

Tools

Un'ampia varietà di raschietti di differenti forme e profili, adatti a molteplici lavorazioni in cucina. /

A wide variety of scrapers of different shapes and profiles, suitable for multiple applications in the kitchen.



Personalizzabili con logo cliente.
Customizable with customer logo.



Code	Dimension (mm)
RA1RS	120×80



Code	Dimension (mm)
RA2RS	120×80



Code	Dimension (mm)
RA3RS	121×81
RA4RS	148×99



Code	Dimension (mm)
RA5RS	145×99



Code	Dimension (mm)
RA6RS	110×80



Code	Dimension (mm)
RA7RS	216×128



Code	Dimension (mm)
RA8RS	216×128



Code	Dimension (mm)
RA9RS	208×128



Code	Dimension (mm)
RA10RS	198×148



Code	Dimension (mm)
SRP	265×125

Raschie in acciaio

Tempered harmonic steel scrapers



Code	Lunghezza length (mm)
RM13	130
RM16	160
RM18	180
RM20	200

Code	Lunghezza length (mm)
RM22	220
RM24	240
RM28	280

Spatole e coltelli

Spatulas and knives

Le misure dei coltelli e delle spatole sono relative alla lama / Dimensions of knives and spatulas are related to blades length



Code	Lunghezza length (mm)
PM64025	250



Code	Lunghezza length (mm)
CM64095	150
CM64100	200
CM64105	250
CM64110	300



Code	Lunghezza length (mm)
PM64012	250
PM64010	170
PM64005	110



Code	Lunghezza length (mm)
PM54129	100
PM54130	120



Code	Lunghezza length (mm)
CM67785	240



Code	Lunghezza length (mm)
CM67777*	240
CM67791*	300
CM67793*	360
CM67781	300

*lama seghettata/ serrated blade

Set tagliapasta Cutters kit

	Code	Stampo mould	Stampi per kit Moulds per kit	dimension (mm)
	STP53B	cerchi lisci smooth circle	9	da - from 20 a - to 80
	STP52B	cerchi festonati festooned circle	9	da - from 20 a - to 80
	STP540B	cerchi lisci robusti strong smooth circle	12	da - from 22 a - to 110
	STP52D	cerchi festonati festooned circle	14	da - from 20 a - to 105
	STP54B	cerchi festonati robusti strong festooned circle	12	da - from 20 a - to 110
	STP61B	ovali lisci smooth oval	9	da - from 27 a - to 85
	STP59	quadrati lisci smooth square	6	da - from 30 a - to 65
	STP58N	quadrati festonati festooned square	5	da - from 35 a - to 80
	STPROML	rombo liscio smooth rhombus	5	da - from 50 a - to 115
	STP55L	esagono liscio smooth hexagon	6	da - from 45 a - to 90
	STP57	goccia liscia smooth drop	6	da - from 45 a - to 95
	STP64	cuore liscio smooth heart	6	da - from 40 a - to 80
	STP65	stella liscia smooth star	6	da - from 45 a - to 85
	STP54L	mezzaluna liscia smooth half-moon	6	da - from 30 a - to 65
	STP67	fiore liscio smooth flower	6	da - from 40 a - to 95
	STP63	foglia liscia smooth leaf	6	da - from 50 a - to 95
	STP31	animali animals	10	
	STP44	forme Natale Christmas shapes	4	
	STP33	lettere letters	26	
	STP34	numeri numbers	9	
	STP46	sagome diverse different shapes	8	
	STP30D	sagome diverse different shapes	12	
	STP00	sagome diverse different shapes	6	

Tagliapasta Pastry cutters

Rotelle tagliapasta Pastry cutters



Code	Ø (mm)	Lama / blade
TP5	55	liscia / smooth
TP6	55	festonata / festooned
TP7	97	liscia / smooth

Taglia croissant Croissant cutters



Code	Dim taglio / cut (mm)
RC1	70×100
RC2	110×150
RC3	180×140
RC4	180×200
RC5	140×200

Tagliapasta estensibili inox Stainless steel extensible pastry cutters



Code	Ø (mm)	Lama / blade
TPO1	55	5 lisce / smooth
TPO2	55	7 lisce / smooth
TPO3	55	5 lisce / smooth 5 festonate / festooned
TPO4	55	7 lisce / smooth 7 festonate / festooned

Rulli taglia o forapasta Pastry dockers



Code	Dimension (mm)
RP1	120



Code	Dimension (mm)
RP2	65



Code	Dimension (mm)
RP3	120



Code	Dimension (mm)
RP4	65



Code	Dimension (mm)
RP5	65

Sessole Scoops

Sessole alluminio Aluminium scoops



Code	Capacity (l)
SEM100	0,1
SEM300	0,3
SEM500	0,5

Code	Capacity (l)
SEM1000	1
SEM1500	1,5
SEM2000	2

Sessole in plastica Plastic scoops



Code	Capacity (l)
SES25	0,025
SES50	0,05
SES100	0,10

Code	Capacity (l)
SES250	0,25
SES500	0,5
SES1000	1



Code	Capacity (l)
SET150	0,15
SET250	0,25
SET500	0,5

Code	Capacity (l)
SET750	0,75
SET1000	1
SET2000	2

Pale pizza Pizza shovel



Code	Lunghezza / length (mm)	
PALA35	360×510 mm	1 pcs × box
PALA57	560×510 mm	1 pcs × box

Palette inox per gelato Stainless steel ice cream spatulas



Code	Lunghezza / length (mm)
PG7	250
PG8	300



Code	Lunghezza / length (mm)
PG7TR	250

Bottiglia Bottle



Personalizzabile con logo cliente. /
Customizable with customer logo.



Code	Capacity (l)
BOTTIGLIA	1

Caraffe Jugs



Code	Capacity (l)
CAG05	0,5
CAG1	1
CAG2	2
CAG3	3
CAG5	5

Imbuti in plastica Plastic funnels



Code	Ø (mm)
IMB8	80
IMB10	100
IMB12	120
IMB14	140
IMB18	180

Colino a pistone inox Stainless steel piston funnel



Code
COLINO

Setacci Sieves



Code	Ø (mm)	Altezza / Height (mm)	Rete / Net meshes (mm)
SETACCIOP05	240	80	0,5
SETACCIOP1	240	80	1
SETACCIOG05	300	90	0,5
SETACCIOG1	300	90	1

Spargifarina inox Flour and sugar stainless steel sifter



Code	Rete / Net meshes (mm)w
SF1M	1

Apriscatole professionale Professional tin opener



Code
AP1

Termometri Thermometers



Code	Measuring range (°C)	
TH5986S	from -50 to +260	Lettura immediata, sonda cavo, memorie. / Immediate reading, probe, memories.



Code	Measuring range (°C)	
TH5989	from -50 to +150	Lettura immediata, sonda fissa in acciaio inox. / Fixed stainless steel probe, immediate reading.

Spazzole Brushes



Code	Dimension (mm)	
SP1	430	setola in crine / horsehair bristle



Code	Dimension (mm)	
SP2	300	ottone e misto / brass and other materials
SP3	300	ottone / brass

Pennelli per dolci Brushes



Code	Dimension (mm)	
34063	40	
43753	60	
43763	75	

Guanti Gloves

Guanti anticalore
Heat-resistant gloves



Resistenza al calore per contatto fino a 350°C per 20 secondi. / It can withstand contact with temperatures up to 350°C for 20 seconds.

Code	Lunghezza / length (mm)
GUANTO/A	365

Guanto in silicone
Silicone glove



Protegge dalle temperature fino a +250°C. / It protects you against temperatures up to +250°C.

Code
CHELATBL CHEF

Vassoi da esposizione Display trays



Code	Dimension (mm)
VE1A	305×225×20 h
VE2A	375×245×20 h

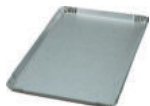

Code	Dimension (mm)
VE1	305×225×20 h
VE2	375×245×20 h

alluminio oxalizzato
oxalate aluminium



Code	Dimension (mm)
VE1G	305×225×20 h
VE2G	375×245×20 h

alluminio oxalizzato versione oro
oxalate aluminium golden version

Kit aerografo Airbrush kit



Sostegno per aeropenna
Airbrush support

Pistola alimentare Food spray gun



Tools

Kit composto da aeropenna a doppia azione completamente in acciaio inox, tubo in gomma con attacchi rapidi, compressore 220 volt, motore non a bagno d'olio e quindi idoneo al contatto con sostanze alimentari. Pressione di uscita 2,5 bar. /

Composed by stainless steel made double action airbrush, hose (no clamp is needed), compressor 220 volt, with non oil engine suitable for foods, outgoing pressure 2,5 bar.

Code

AEROGRAFO

Code

AEROPENNA

Code

RG2

Kit aerografo utilizzabile con colori liquidi idrosolubili - vedi pag 352 / Airbrush kit can be used with water-soluble colours - see page 352

Ideale per erogare ogni liquido a media e bassa viscosità come burro, olio, gelatina, salse, ecc. e per spruzzare superfici piane e oggetti come leccarde o vassoi. /

Ideal to spray low to medium viscosity liquids including butter, oil, jelly and sauces etc. and spray flat surfaces and objects like trays and pans.

Pistola alimentare utilizzabile con colori al burro di cacao - vedi pag 351 / Food spray gun can be used with cocoa butter colours - see page 351

Code	Capacity (l)	Pressione max dinamica max dynamic pressure (bar)	Potenza power (V)	Potenza nominale rated power (W)
W200	0,7	160	220	60

Lampada per zucchero su richiesta Sugar heating lamp on demand

Interamente in acciaio inox, completa di cassetto porta attrezzi, variatore di potenza e due resistenze porcellanate. / Completely stainless steel made, provided with drawer for tools, power variator and two porcelain resistances.

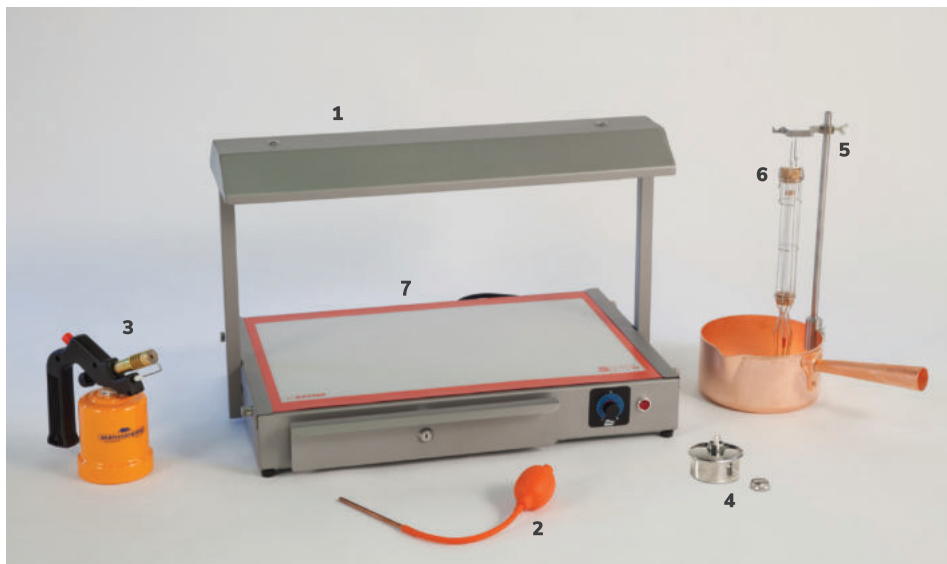

Code	Potenza power (w)	Tensione d'esercizio voltage (v)	Piano di lavoro working plan (mm)	Peso weight (kg)
1.LAMPADA	800	230	600×400	14

Code	Description	Code	Description
2.POMPETTA	con terminale in rame pump with copper terminal	5.RG1	reggi caramellometro holder for sugar thermometer
3.CANNELLO	con accensione automatica torch with automatic ignition	6.CARAMELLOMETRO	con gabbia /sugar thermometer with housing
4.BAZ	bocchetta alcool con stoppino stainless steel bottle with alcool wick	7.SP64	tappetino mat

Cannello a gas Blow torch



Tools

Cannello dalla fiamma mediamente sottile, robusto e ideale per la lavorazione dello zucchero artistico e caramellature. / Torch with thin flame, robust and ideal for the processing of the artistic sugar and caramelization.

Code

FLAME

Aladin - lampada per zucchero Aladin - sugar heating lamp



Lampada a infrarossi a due potenze selezionabili: 600 e 1200 W. Struttura e piano di lavoro in acciaio inox. Completamente smontabile. Cavo di alimentazione incluso / Infrared lamp with two switchable powers: 600 and 1200 W. Stainless steel structure and working plan. Fully demontable. Power cable included.

Code	Piano di lavoro working plan (mm)	Peso weight (kg)
------	--------------------------------------	---------------------

ALADIN	610x410	6
--------	---------	---

Pettini Combs

Pettine Charlotte
Charlotte comb



Pettine Charlotte con telaio, in acciaio inox. Appoggia il telaio sul tappetino SPV e stendi il biscuit uniformemente, poi posiziona il pettine sul telaio e tiralo verso di te. / Charlotte comb with stainless steel frame. Put the frame on the SPV mat and spread uniformly the biscuit. Place the comb on its frame and pull towards you.

Code	Pettine comb size (mm)	Telaio frame size (mm)
PCT	705x110	570x370x10 h

Pettine
Comb



Pettine con 5 fasce in gomma alimentare a doppio decoro. Spatola uniformemente la pasta decoro sul tappetino SPV, poi appoggia il pettine e tiralo nella direzione desiderata e poni in congelatore. Stendi poi il biscuit aiutandoti con la raplette e cuoci in forno. Infine, appoggia il biscuit su un foglio e togli delicatamente il tappetino SPV. / Comb provided with 5 rubber blades with 2 different decorations. Spread uniformly the decorating paste on the SPV mat. Using the comb rake in the chosen direction. Put it in a freezer. By using the raplette spread the biscuit and bake it. Place the biscuit on a graseproof paper and carefully remove the SPV mat.

Code

PETTINE

Tools

Raplette



Raplette in acciaio inox regolabile sia in altezza che in larghezza.
Stainless steel raplette adjustable in both height and width.

Code	Larghezza max Max width (mm)	Altezza max Max height (Mm)
RAPLETTE	400	da 0 a 15 / from 0 to 15

Asciugaverdure Vegetable dryers





Economico, robusto e sicuro, realizzato a norma CE. Le parti metalliche sono in alluminio ed acciaio inox, gli ingranaggi sono in resina termoplastica antiurto e antiusura. Il modello da 25 litri ha anche la possibilità di scarico diretto dell'acqua residua: è sufficiente applicare la cannetta nell'apposita sede posta sul fondo dello stesso. / Affordable, robust and safe, and made according to CE standards. The metal parts are made of aluminium and stainless steel, the internal components are made of shockproof and wear-resistant thermoplastic resin. The 25 liters model also offers the possibility of directly draining residual water: simply insert the hose in the slot on the base.

Code	Altezza height (mm)	Ø (mm)	Capacity (l)	Peso weight (kg)
GREENMATIC12	430	330	12	2,8
GREENMATIC25	520	430	25	4

Teglie Trays

Una gamma di teglie solide e robuste, resistenti alla deformazione: forate e piene, rivestite in teflon, in alluminio e in lamiera, con dimensioni e bordi differenti. / A range of solid and sturdy trays, resistant to warping: perforated and non-perforated, coated in teflon, aluminium or steel, in various sizes and with various edge heights.

Teglie piane forate in alluminio Perforated trays in aluminium	Code	Dimension (mm)	Altezza bordi edges height (mm)	Spessore thickness
	JF04030D20P00G	400×300	20	15/10
	JF06040D20P00G	600×400	20	15/10
	JF08060D20P00G	800×600	20	15/10
Rivestite in teflon verde 5 mani 5 layers of green teflon	Code	Dimension (mm)	Altezza bordi edges height (mm)	Spessore thickness
	JF04030D20P00V*	400×300	20	15/10
	JF06040D20P00V*	600×400	20	15/10
	JF08060D20P00V*	800×600	20	15/10
Teglie piane piene in alluminio Flat trays in aluminium	Code	Dimension (mm)	Altezza bordi edges height (mm)	Spessore Thickness
	JH04030D20P00G	400×300	20	15/10
	JH04030D30P00G	400×300	30	15/10
	JH05030D20P00G	500×300	20	15/10
	JH06040D20P00G	600×400	20	15/10
	JH06040D30P00G	600×400	30	15/10
	JH06040D40P00G	600×400	40	15/10
	JH08060D20P00G	800×600	20	15/10

Tools

Rivestite in teflon verde 5 mani 5 layers of green teflon	Code	Dimension (mm)	Altezza bordi edges height (mm)	Spessore thickness
	JH06040D20P00V*	600×400	20	15/10



Teglie piane piene in lamiera alluminata Flat trays in aluminate steel	Code	Dimension (mm)	Altezza bordi edges height (mm)	Spessore thickness
	JS04030D20P00G	400×300	20	8/10
	JS06040D10P00G	600×400	10	8/10
	JS06040D20P00G	600×400	20	8/10
	JS06040D30P00G	600×400	30	8/10
	JS06040D40P00G	600×400	40	8/10
	JS08060D20P00G	800×600	20	8/10



Rivestite in teflon verde 5 mani 5 layers of green teflon	Code	Dimension (mm)	Altezza bordi edges height (mm)	Spessore thickness
	JS04030D20P00V*	400×300	20	8/10
	JS06040D10P00V*	600×400	10	8/10
	JS06040D20P00V*	600×400	20	8/10
	JS06040D30P00V*	600×400	30	8/10
	JS06040D40P00V*	600×400	40	8/10
	JS08060D20P00V*	800×600	20	8/10



* Disponibili in 15 giorni lavorativi /
Available in 15 working days

Pilly



Un'idea semplice dalla grande efficacia: un piccolo triangolo per impilare e agganciare tra loro teglie da cottura ad angolo retto, in modo sicuro, facile e stabile. Ideale per risparmiare spazio nel laboratorio, nel trasporto per il catering e per sovrapporre i preparati dolci o salati prima, durante e dopo la cottura. Prodotto in silicone alimentare resistente a temperature da -40°C a +250°C. Prodotto brevettato. /

A simple idea with great results: a small triangle for stacking and attaching baking trays at right angle to each other in a safe, easy and secure way. Ideal for saving space in the kitchen, transporting for catering and stacking sweet or savoury dishes before, during and after cooking. Food-grade silicone product resistant to temperatures from -40°C to +250°C. Patented product.

Code	Pcs per kit
PILLY4	4



Carrelli fissi Fixed trolleys

Modelli e dimensioni a richiesta, un'ampia scelta di personalizzazioni disponibili e dettagli strutturali pensati per la massima efficienza: guide angolari in acciaio inox AISI 304, ruote termiche resistenti alle alte temperature e cuscinetti per un affiancamento facile e sicuro. /

Models and sizes available on request. A wide range of customisations available as well as structural details designed for maximum efficiency: AISI 304 stainless steel angular guides, high-temperature resistant wheels and bearings for easy and safe positioning.

Carrello portateglie a guide angolari
Trolley for trays with angular guides

Code

Dimension
(mm)Altezza
Height
(mm)Piani
LevelsDistanza piani
Level spacing
(mm)

YI06040C18SF

600×400

1850

18

90

YI08060C18SF

800×600

1850

18

90

Carrello portateglie a pioli
Trolley with hooks

Code

Dimension
(mm)Altezza
Height
(mm)Piani
LevelsDistanza piani
Level spacing
(mm)

YI06040P20SF

600×400

1870

20

80

YI06040P40DF

600×400

1870

40

80

Carrello per forno
Trolley for ovens



Ruote termiche resistenti ad alte temperature /
Thermal wheels resistant to high temperatures.



Carrello porta marne
Trolley for carrying dollies



Estremità guide angolari /
Angular guides



chiusa
closed



aperta
open













chiusa aperta
closed open

Cestelli Racks

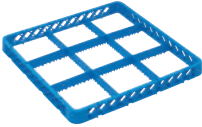

Resistenti agli urti e alle alte temperature, leggeri e maneggevoli, i cestelli sono pensati per essere facilmente impilabili. Realizzati con ampie finestre per una circolazione ottimale dell'acqua, evitano residui di detersivo e accelerano le asciugature. / Resistant to impact and high temperatures. Light and easy to handle, easily stackable. Designed with large openings for optimal water circulation, avoiding the buildup of detergent and speeding up drying.

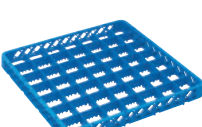

Basi per cestelli Base racks	Code	Dim. esterna outside dim. (mm)	Altezza interna inside height (mm)	Description	Details
	CBU	500×500×103	83	universale aperta universal open	
	CB09	500×500×103	83	9 scomparti 9 compartments	149 mm lato - side 211 mm diagonale - diagonal
	CB16	500×500×103	83	16 scomparti 16 compart- ments	113 mm lato - side 154 mm diagonale - diagonal
	CB25	500×500×103	83	25 scomparti 25 compart- ments	90 mm lato - side 125 mm diagonale - diagonal
	CB36	500×500×103	83	36 scomparti 36 compart- ments	73 mm lato - side 103 mm diagonale - diagonal
	CB49	500×500×103	83	49 scomparti 49 compart- ments	62 mm lato - side 87 mm diagonale - diagonal
	CBV	445×445×105	85	per piatti e vassoi for plates and trays	7×5 pioli - pegs 43×57 mm distanze tra i pioli - distance between pegs
	CBVA	500×500×103	83	per vassoi grandi for large trays	8×8 pioli - pegs 43×57 mm distanze tra i pioli - distance between pegs
	CBP	500×500×103	83	per posate for flatware	



Rialzi Extenders	Code	Dim. esterna outside DIM. (mm)	Description	Details
	CRU	500×500×44	universale universal	
	CR09	500×500×44	9 scomparti 9 compartments	149 mm lato - side 211 mm diagonale - diagonal
	CR16	500×500×44	16 scomparti 16 compartments	113 mm lato - side 154 mm diagonale - diagonal
	CR25	500×500×44	25 scomparti 25 compartments	90 mm lato - side 125 mm diagonale - diagonal
	CR36	500×500×44	36 scomparti 36 compartments	73 mm lato - side 103 mm diagonale - diagonal
	CR49	500×500×44	49 scomparti 49 compartments	62 mm lato - side 87 mm diagonale - diagonal

Accessori per cestelli
Accessories for racks

	Code	Dimension (mm)	Description
	CCOP	500×500×20	Coperchio standard / Standard lid
	CPOS	428×205×150	Cestello per posate a 8 scomparti / 8 compartment flatware basket

Tools

Accessori per cestelli
Accessories for racks

	Code	Dimension (mm)	Description
	CARCL	500×500×20	Carrello inox / Stainless steel trolley
	CARCAM	428×205×150	Carrello inox con maniglione / Stainless steel trolley with handle

Griglie porta piatti
Dish racks

In plastica per contenitori Europa. Disponibili nei modelli a 26 posti, per piatti con diametro max 320 mm, e 32 posti per piatti con diametro max 260 mm. /

In plastic, for Europa containers. Available in models with 26 slots, for plates with a maximum diameter of 320 mm, and 32 slots for plates with a maximum diameter of 260 mm.



Code	Max Ø piatti dishes (mm)	N° divisori n compartments
GRIGLIA26	320	26
GRIGLIA32	260	32

Contenitori
Crates





Contenitori in plastica

Plastic crates

Materiali Materials



Polietilene alta densità HDPE / High density polyethylene HDPE
Uno dei materiali termoplastici più resistenti, anche ad acidi e basi, e all'impatto a basse e alte temperature (da -30°C a +70°C).
HDPE is one of the most resistant thermoplastic materials, even against acids and bases, as well as against low and high temperatures (range: from -30°C to +70°C).



Polietilene bassa densità LLDPE / Low density polyethylene LLDPE
Materiale resistente, più duttile e meno rigido del polietilene alta densità, dotato di una buona resistenza all'impatto e ritorno alla deformazione. Ideale per usi a basse temperature. / This resistant material is more ductile and less rigid than high density polyethylene. It is endowed with adequate impact resistance and springback following deformation. Ideal for use at low temperatures.



Polipropilene PP / Polypropylene PP
Copolimero termoplastico estremamente resistente, anche ad acidi e basi, elastico, con un'eccellente resistenza all'impatto, ritiro ed indurimento della superficie. Adatto ad applicazioni dove è richiesta resistenza alle alte temperature (da -20°C a +90°C). / PP is a thermoplastic copolymer that is extremely resistant even against acids and bases. It is elastic and endowed with optimal characteristics in terms of impact resistance, shrinkage and hardening of the surface. It is suitable for applications in which resistance to high temperatures is required (from -20°C to +90°C).



EPP
Polipropilene espanso, con eccellenti proprietà di isolamento termico.
Foam polypropylene is endowed with optimal heat insulation properties.



ABS
Materiale con ottime proprietà costruttive (resistenza all'impatto) e meccaniche (facilità di lavorazione). / ABS is a material endowed with excellent construction properties (impact resistance) and mechanical properties (ease of working).

Altri - Other materials



Altre plastiche, tra le quali polimetilmetacrilato, policarbonato, poliammide.
Other plastics, such as polymethyl methacrylate, polycarbonate and polyamide.

Acciaio Inox AISI 304 - AISI 304 stainless steel

Tutti i materiali sono rispondenti alla legislazione vigente che disciplina le caratteristiche degli imballaggi e dei contenitori destinati al contatto con gli alimenti. / All materials are compliant with current legal requirements governing the characteristics of packaging and containers coming into contact with foods.

Simboli Symbols



Sovrapponibili /
Stackable



Inseribili /
Nesting



Coperchio /
Lid



Carrello /
Trolley

Il numero di pezzi per pallet indicato nelle tabelle è in riferimento allo standard EUR 1000×1200. / The number of pieces per pallet indicated in the tables is as provided by the EUR 1000×1200 standard.

Serie Europa Europa Series

Numerose soluzioni specializzate che abbinano differenti dimensioni, pareti, fondi e accessori specifici. Le pareti a retinatura traspirante consentono il passaggio di aria e liquidi. Il fondo, chiuso o forato, impedisce flessioni sul piano di caricamento e può essere scelto in base a peso, robustezza e destinazioni d'uso. I coperchi, disponibili con ganci o senza, mettono le merci al sicuro da danni di trasporto e sporcizia. Le maniglie per la movimentazione sono personalizzabili, fra passanti e chiuse in diverse combinazioni per la massima comodità di utilizzo. Un'ampia gamma di colori personalizzabili a richiesta.

Many specialized solutions combining a variety of dimensions, sides, bottoms and specific accessories. The breathable transparent screen sides enable the passage of air and liquids. The bottom may be closed or perforated and prevents bending at the loading level. The bottom may be selected on the basis of weight, strength and ambits of use. Lids are available with or without hooks, to protect the goods against harm during transport and avoid soiling. The handles included for handling purposes can be customized (hole handles, closed handles and various combinations of these, for optimal user-friendliness). A wide range of customized colours according to your requirements.

EF	6407	G	4MP
Fondo e pareti Bottom and sides	Dimensioni Dimension	Tipo di fondo Type of bottom	N° e tipologia maniglie N° and type of handles
E Fondo chiuso e pareti chiuse Closed bottom and closed sides	6	4	07
EF Fondo forato e pareti forate Perforated bottom and perforated sides	Larghezza Width	Profondità Depth	Altezza Height

Legenda maniglie Handles legend

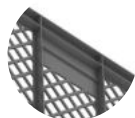

MC
Maniglie chiuse
Closed handles

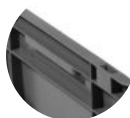

ME
Maniglie esterne
External handles

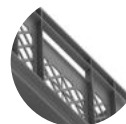

MP
Maniglie passanti
Hole handles

Legenda fondi
Bottoms legend

I fondi lisci A - S sono fondi piani ideali per lo scorrimento silenzioso su sistemi automatizzati di produzione e movimentazione. Il fondo forato F è un fondo a retinatura traspirante, per il passaggio di aria e liquidi, ideale per contenere prodotti di piccole dimensioni. I fondi rinforzati B - I - T sono fondi chiusi altamente resistenti alla deformazione; il fondo B è adatto alla sovrapposizione di contenitori 400×300 mm.

The smooth bottoms A – S are flat bottoms ideal for ensuring low noise during handling by automated production and handling systems. The bottom F features a perforated screening solution for the passage of air and liquids. Ideal for containing small products. The reinforced bottoms B – I – T are closed bottoms highly resistant to deformation. Bottom B is suitable for stacking 400×300 mm containers.

Fondi lisci
Smooth bottoms

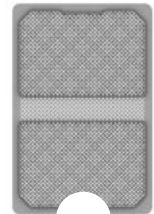

400×300 mm

Fondi forati
Perforated bottoms

Fondi rinforzati
Reinforced bottoms

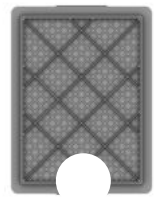
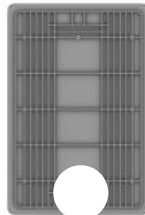
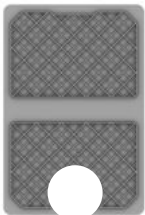

400×300 mm

Serie Europa 600×400 mm Europa Series 600×400 mm

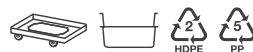

Contenitori colorati ad uso alimentare
Coloured containers for food contact

Ceste sovrapponibili e impilabili per alimenti, realizzate con polimeri particolari che assicurano la massima igiene, grazie alla resistenza a muffe e batteri. Facilmente lavabili. Ogni colore ha la sua destinazione d'uso per una razionalizzazione degli stoccaggi e nessun rischio di contaminazione.

Stackable food crates made of special polymers that ensure maximum hygiene due to their resistance to mildew and bacteria. Easily washable. Each colour has its intended use for rationalised storage and no risk of contamination.

Serie E Performance E Series Performance	Code	Fondo Bottom	Dim. interne inside Dim. (mm)	Vol (lt)	4MP	4MC	2ME	2MP+ 2MC	2Me+ 2MC	Pcs per pallet
	E6407	A	565×365×65	13		•				160
	E6410	A	565×365×95	19		•				110

Fondo chiuso e pareti chiuse / Closed bottom and closed sides



Carni crude /
Raw meats

E6407FLRS
E6410FLRS



Carni bianche /
Poultry

E6407FLGL
E6410FLGL



Frutta e
verdura /
Fruits and
vegetables

E6407FLVR
E6410FLVR



Cibi per intol-
leranze senza
allergeni / Food
intolerances and
without allergens

E6407FLVL
E6410FLVL



Lievitazione
impasti 24 ore /
24 hours dough
leavening

E6407FLAZ
E6410FLAZ



Lievitazione
impasti 72 ore /
72 hours dough
leavening

E6407FLNR
E6410FLNR



Impasti pizza,
pane e
latticini /
Pizza dough,
bread and dairy
products

E6407FLNT
E6410FLNT



Pesce /
Fish











E6407FLBL
E6410FLBL



Lievitazione
impasti 48 ore /
48 hours dough
leavening

E6407FLGR
E6410FLGR

Contenitori in plastica / Plastic crates

Serie e Performance E Series Performance	Code	Fondo Bottom	Dim. interne inside Dim. (mm)	Vol (lt)	4MP	4MC	2ME	2MP+ 2MC	2Me+ 2MC	Pcs per pallet	Colour
	E6413	A	565×365×120	24		•				85	
	E6415	B	565×365×140	28				•		70	
	E6420	B	565×365×185	38				•		50	
	E6426	B	570×370×255	53				•	•	40	
	E6429	B	570×370×275	58				•		35	
	E6432	B	570×370×305	64				•	•	35	
	E6435	B	570×370×335	70				•		30	
	E6441	I	570×365×395	82				•		25	
E6445	I	570×365×435	90				•	•	25		

Fondo chiuso e pareti chiuse / Closed bottom and closed sides



Serie E Light E Series Light	Code	Fondo bottom	Dim. interne inside Dim. (mm)	Vol (lt)	4MC	Pcs per pallet	Colour
	E6407L	A	565×365×70	14	•	160	
	E6409L	A	565×365×85	17	•	110	



Fondo chiuso e pareti chiuse / Closed bottom and closed sides

Serie EF / EF Series	Code	Fondo bottom	Dim. interne inside Dim. (mm)	Vol (lt)	4MC	Pcs per pallet	Colour
	EF6407	F	565×365×55	11	•	160	
	EF6410	F	565×365×85	17	•	110	

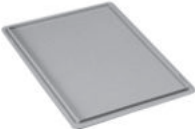
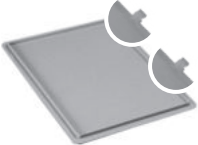



Per i codici EF6407 e EF6410 pareti con pattern fori piccoli
For EF6407 and EF6410 codes, sides are with small holes pattern

Coperchi Lids	Code	Dim. esterne / outside Dim. (mm)	PCS per pallet	Colour	
	COPE64N	600×400×20	700	<input type="checkbox"/> <input checked="" type="checkbox"/>	Coperchio da appoggio Lid providing support
	COPE64N C/G	600×400×20	700	<input type="checkbox"/> <input checked="" type="checkbox"/>	Con ganci With hooks
	COPEN64	610×410×45	700	<input type="checkbox"/> <input checked="" type="checkbox"/>	Con bordo avvolgente With upturned lip



Carrelli Trolleys	Code	Description	
	CARE/P	Carrello in plastica. Plastic trolley.	
	CARE/I	Carrello inox. Stainless steel trolley.	

Serie Europa 400×300 mm
Europa Series 400×300 mm



Serie E E Series	Code	Fondo Bottom	dim. interne inside Dim. (mm)	vol (lt)	2Me	Pcs per pallet	Colour
	E4312	T	370×270×117	12	•	180	<input type="checkbox"/> <input type="checkbox"/>
		S	370×270×117	12	•	180	<input type="checkbox"/> <input type="checkbox"/>
	E4317	T	370×270×167	17	•	130	<input type="checkbox"/> <input type="checkbox"/>
		S	370×270×167	17	•	130	<input type="checkbox"/> <input type="checkbox"/>
	E4322	T	370×270×217	22	•	100	<input type="checkbox"/> <input type="checkbox"/>
		S	370×270×217	22	•	100	<input type="checkbox"/> <input type="checkbox"/>
	E4332	T	370×270×317	32	•	70	<input type="checkbox"/> <input type="checkbox"/>
		S	370×270×317	32	•	70	<input type="checkbox"/> <input type="checkbox"/>

Fondo chiuso e pareti chiuse / Closed bottom and closed sides

Coperchi Lids	Code	dim. esterne outside Dim. (mm)	Pcs per pallet	Colour	
	COPE43N C/G	400×300×20	540	<input type="checkbox"/> <input type="checkbox"/>	Con ganci With hooks
	COPE43N S/G	400×300×20	560	<input type="checkbox"/> <input type="checkbox"/>	Senza ganci Without hooks



Serie S S Series



Contenitori sovrapponibili con maniglie esterne, con fondo chiuso e pareti chiuse. Sono ideali per bighe, impasti e pasticceria fresca di ogni genere, perché facili da pulire e igienicamente sicuri. Le maniglie di cui sono dotati rendono la movimentazione a mano facile e veloce, mentre i coperchi, disponibili in tutte le differenti dimensioni, assicurano massima tenuta e igiene.

Stackable containers with external handles, a closed bottom and closed sides. These containers are ideal for dough and fresh pastries of all kinds, since they are readily cleanable and safely hygienic. The handles facilitate rapid manual handling operations. The lids, available for all dimensions, assure perfect seal and hygiene.

Serie SL / SL Series	Code	dim. esterne outside Dim. (mm)	dim. interne inside Dim. (mm)	vol (lt)	Pcs per pallet
	SL1	650×427×65	600×400×60	18	180
	SL2	650×427×115	600×400×110	26	90
	SL3	650×427×83	600×400×80	19	120
Fondo chiuso e pareti chiuse / Closed bottom and closed sides					

Coperchi / Lids	Code	dim. esterne outside Dim. (mm)		
	COPSL	665×445×30	Coperchio per serie SL Lid for SL series	

Serie SLX / SLX Series	Code	Dim. esterne outside Dim. (mm)	Dim. interne inside Dim. (mm)	vol (lt)	Pcs per pallet
	SLX1	657×455×83	600×400×72	18	135
Fondo chiuso e pareti chiuse / Closed bottom and closed sides					
<p>Contenitori sovrapponibili, con fondo e pareti chiuse. Impilabili sia in modo tradizionale sia a croce, grazie ai ganci appositi. Questo permette la circolazione di aria nei contenitori, rendendo ideale la lievitazione. / Stackable crates with closed bottom and sides. SLX Series is also cross stackable, thanks to the specific hooks. This allows the air circulation through the crates, easing the rising or any other application for which air circulation is required, without compromising space saving.</p>					

Serie I I Series





I contenitori inseribili Serie I sono realizzati in polietilene a bassa densità e sono l'ideale per il settore della ristorazione e del catering. Resistenti agli agenti chimici e idonei all'uso alimentare, sono disponibili con pareti chiuse o forate e coperchi per le differenti dimensioni.

The containers of the I Series are produced in low density polyethylene. They are ideal for the sector of Ho.Re.Ca. and catering. They are also resistant against chemical agents. Suitable for food use, these containers are available with closed or perforated sides and lids for the various dimensions.

Serie I - I Series	Code	Dim. esterne outside Dim. (mm)	Dim. interne inside Dim. (mm)	Vol (lt)	Pcs per pallet
	I4	570×360×340	502×312×330	40	350
	I6N	660×450×340	594×402×330	60	250
	I10	780×520×400	685×480×380	100	90
Fondo chiuso e pareti forate / Closed bottom and perforated sides					

Serie IC / IC Series	Code	Dim. esterne outside Dim. (mm)	Dim. interne inside Dim. (mm)	Vol (lt)	Pcs per pallet
	IC4	570×360×340	502×312×330	40	350
	IC6	660×450×350	582×392×300	60	250
	IC10	780×520×400	685×480×380	100	90
Fondo chiuso e pareti forate / Closed bottom and perforated sides					

Coperchi / Lids	Code	dim. esterne outside Dim. (mm)	Pcs per pallet	
	COPI4	590×370×20	250	Coperchio per I/IC4 Lid for I/IC4
	COPI6N	680×475×20	200	Coperchio per I/IC6 Lid for I/IC6

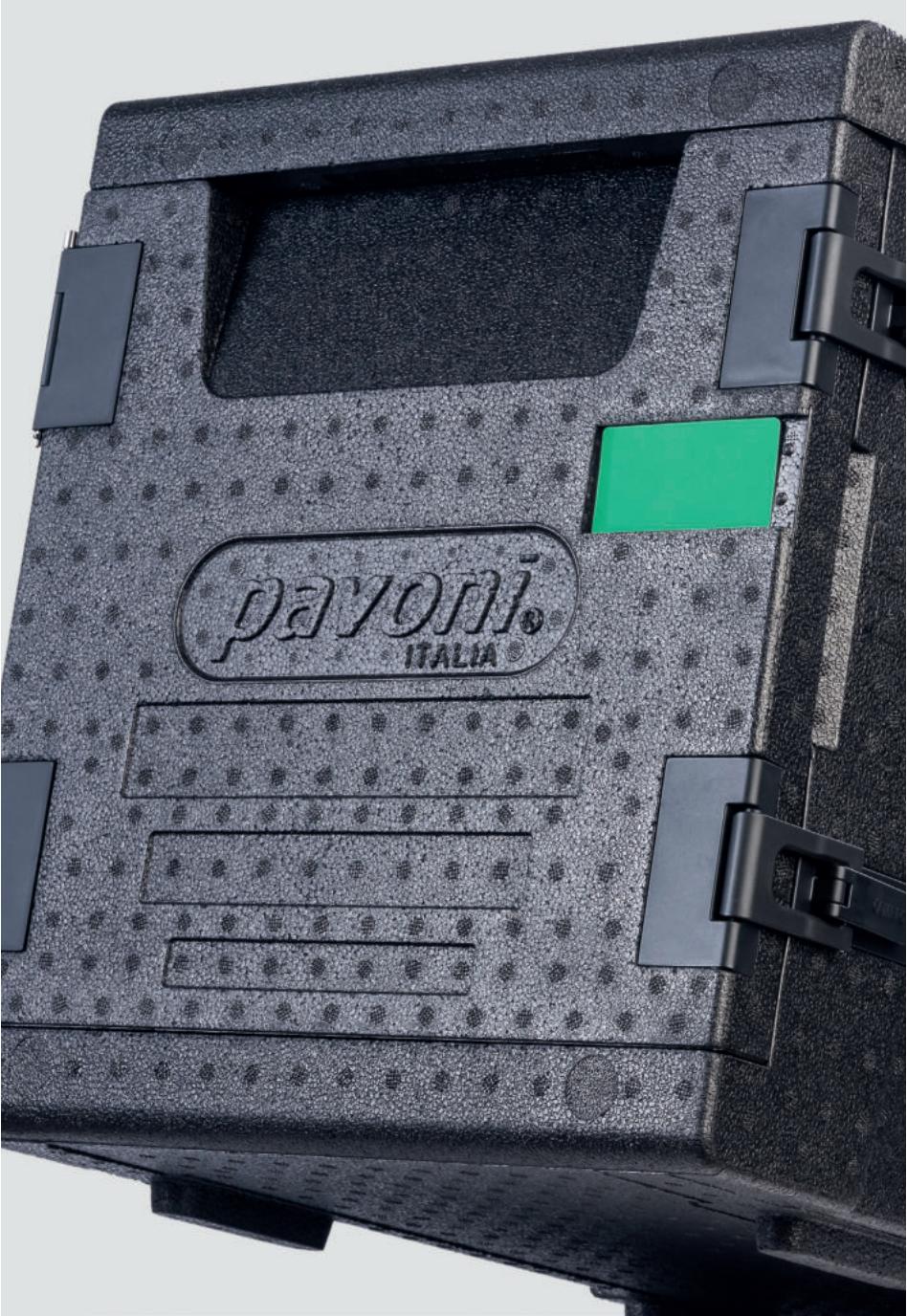

Termobox

La linea di contenitori Termobox è ideale per le aziende della ristorazione, del catering e dell'Ho.Re.Ca. Contenitori leggerissimi, capaci di un'ottima tenuta della temperatura delle pietanze e prodotti contenuti al loro interno, dotati di un'eccellente resistenza all'usura. I Termobox sono progettati mettendo la sicurezza al primo posto, sia durante la movimentazione che nella conservazione delle merci: assicurano agli alimenti il mantenimento di temperature inferiori a +4°C o superiori a 65°C per molte ore durante la conservazione e il trasporto. Una facile pulizia e la riduzione di potenziale contaminazione incrociata completano le caratteristiche di una linea di grande successo. /

The Termobox line of containers is ideal for Ho.Re.Ca. restaurants and catering establishments. These containers are extremely lightweight and excellently maintain the temperatures of dishes and other products contained. They are also resistant to wear and tear. Termobox containers were designed to ensure safety above all, during both goods handling and storage operations. They maintain temperatures of less than +4°C or higher than 65°C for many hours during storage and transport operations. The containers are readily cleanable. Potential cross-contamination is curbed. Thanks to these characteristics, this line of products has been extremely successful.



Leggeri, realizzati in EPP (polipropilene espanso) un materiale dalle alte prestazioni e rispettoso dell'ambiente. / Lightweight, and manufactured in EPP (foam polypropylene). The performance ratings of this environmentally compatible material are impressively high.



Chimicamente inerti, non vengono attaccati da olio, grasso e dalla maggior parte delle sostanze chimiche. / Since these containers are chemically inert, they are impervious to oils, greases and most chemical substances.



Elevata resistenza agli impatti senza riportare danni, grazie all'eccellente assorbimento dell'energia meccanica. / Markedly impact resistant, with no damage ensuing, thanks to the optimal level of absorption of mechanical energy.



Grazie all'eccezionale forza strutturale sono in grado di sopportare carichi pesanti mantenendo la loro forma. / Thanks to this material's extraordinary structural strength, these containers can bear heavy loads with no deformation.



Lavabili in lavastoviglie. / Dishwasher safe.



Adatti per prodotti alimentari. / Suitable for foods.



Riciclabili al 100%. / 100% recyclable.

Termobox a caricamento dall'alto Top-loader Termobox



I Termobox a caricamento dall'alto sono dotati di un design esclusivo, che permette di risparmiare fino al 30% di spazio. Gli incavi delle pareti interne dei Termobox facilitano il caricamento e lo scaricamento delle bacinelle GN 1/1 e 1/2, mentre l'apposito spazio prestampato permette l'inserimento di targhette identificative. I manici sono ergonomici, per un sollevamento facilitato e sicuro, e l'impilabilità è garantita anche con contenitori di terze parti presenti sul mercato.

Top-loader Termobox containers are the outcome of an exclusive design idea, capable of saving up to 30% of the available space. The grooves in the internal sides of Termobox containers facilitate loading and unloading the GN 1/1 and 1/2 trays. A pre-stamped space may be used to add ID labels. The handles are ergonomic, thus facilitating safe lifting. Stackability is assured, also with containers of third parties present within the marketplace.



Facile carico e scarico con i comodi incavi nelle pareti interne / Easy to load and unload with conveniently grooved inner sides

Manici ergonomici per movimentazione in sicurezza
Ergonomic handles for safe handling

Semplice identificazione utilizzando l'apposito spazio per etichette / Identification facilitated thanks to inclusion of a space for labels



Conservazione di cibi caldi /
Storage of hot food

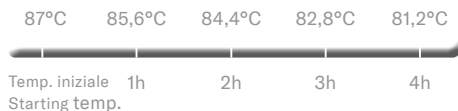

Nota: Si otterranno i migliori risultati caricando le bacinelle a temperature comprese fra 82°C e 88°C. Il caricamento di bacinelle in metallo a temperature superiori ai 120°C può causare danni al contenitore.



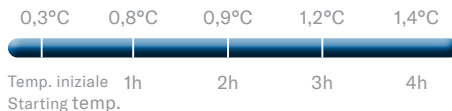

Conservazione di cibi freddi /
Storage of cold food





NB: The best results are obtained by loading the trays at a temperature in the 82°C-88°C range. Temperatures higher than 120°C may damage the container.

Termobox

Per bacinelle GN 1/2
For GN 1/2 holdings

	Code	Dim. esterne outside Dim. (mm)	Dim. interne inside Dim. (mm)	Peso weight (kg)	Vol (lt)	Colour
	TB4326	390x330x257	330x270x193	0,62	16,9	■
	TB4332	390x330x316	330x270x253	0,70	0,70	■



Per bacinelle GN 1/1
For GN 1/1 holdings

	Code	Dim. esterne outside Dim. (mm)	Dim. interne inside Dim. (mm)	Peso weight (kg)	vol (lt)	Colour
	TB6426	600x400x257	538x338x195	1,07	35,5	■
	TB6432	600x400x316	538x338x254	1,20	46	■

Impilabile per bacinelle GN 1/1
Stackable for GN 1/1 holdings

	Code	Dim. esterne outside Dim. (mm)	Dim. interne inside Dim. (mm)	Peso weight (kg)	vol (lt)	Colour
	TB6432N	600x400x316	538x338x254	1,13	43	■

30% di risparmio in volume grazie al design ad impilaggio interno. /
30% space saving thanks to the internal stacking design solution.

Per casse per prodotti da forno For crates for bakery products	Code	Dim. esterne outside Dim. (mm)	Dim. interne inside Dim. (mm)	Peso weight (kg)	Vol (lt)	Colour
	TB7527	690×490×270	625×425×205	1,40	53	■
	TB7537	690×490×370	625×425×305	1,70	80	■

Termobox a caricamento frontale Front-loader Termobox

I Termobox a caricamento frontale sono pratici e pensati per la semplicità d'utilizzo. Uno scomparto per piastre calde o fredde è posto sulla parete posteriore interna per evitare sgocciolamenti di condensa dall'alto e favorire la distribuzione uniforme della temperatura in tutto il contenitore. Sulla parte alta, una comoda impugnatura perimetrale permette la movimentazione comoda e sicura su tutti 4 i lati. L'apertura e chiusura sono facilitate dallo sportello coi bordi smussati mentre le cerniere e la serratura a scatto in nylon permettono allo sportello di aprirsi a 270°.



Conservazione di cibi caldi /
Storage of hot food

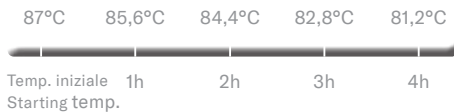

Nota: Si otterranno i migliori risultati caricando le bacinelle a temperature comprese fra 82°C e 88°C. Il caricamento di bacinelle in metallo a temperature superiori ai 120°C può causare danni al contenitore.

Front-loader Termobox containers are a solution designed for practicality and user-friendliness. A division is provided for eutectic plates or icing boxes. The division is fitted on the inner back side in order to curb dripping and condensation from above, and in order to enable uniform distribution of the temperature desired within the box as a whole. The top includes a perimeter hand grip for safe, convenient handling on all 4 sides. Opening and closing are facilitated by inclusion of the door with rounded edges. The door can be opened to 270° thanks to the hinges and snap latch in nylon.

Comoda apertura e chiusura grazie ai bordi smussati dello sportello / Easy to open and close thanks to the rounded edges of the door

Design intelligente con comparto interno per piastre calde o fredde, per distribuire la temperatura e impedire sgocciolamenti. / Smart design with inner division for eutectic plates or icing boxes, to distribute the temperature and prevent dripping

Semplice identificazione utilizzando l'apposito spazio per etichette
Simply identifiable using the space provided for labels

Facile movimentazione in sicurezza con comode impugnature perimetrali / Easy to handle in safe conditions, thanks to the perimetral hand grips

Accesso a 270° facilitato dall'ampia apertura dello sportello. Chiusura rinforzata / Opening at 270° access to the products facilitated by the door that can be fully opened. Reinforced closure

Anti-sgocciolamento Il rilievo incorporato sul fronte inferiore evita la fuoriuscita di liquidi. / Anti-drip the upturned lip on the bottom of the front prevents liquids from escaping



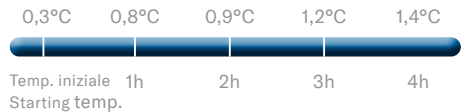

Conservazione di cibi freddi /
Storage of cold food



NB: The best results are obtained by loading the trays at a temperature in the 82°C-88°C range. Temperatures higher than 120°C may damage the container.

Senza guide Without rails	Code	Dim. esterne outside Dim. (mm)	Dim. interne inside Dim. (mm)	Peso weight (kg)	Vol (lt)	Colour
	TB7569	770×540×687	615×410×585	6,10	155	■
<p>Contenitori multiuso senza guide per il trasporto di casse, teglie e vassoi di 600×400 mm. Può essere modificato con guide regolabili in acciaio inossidabile opzionali, KITADJR*, per il trasporto di casse da 600×400 mm, bacinelle e teglie da forno nella stessa unità. / These multi-use containers without rails were designed for transporting crates, pans and trays (600×400 mm). These containers can also be modified for greater versatility with the inclusion of optional adjustable rails in stainless steel, KITADJR*, for transporting 600×400 mm crates, trays and baking pans in the same unit.</p> <p>* Vedere gli accessori. / * See the accessories.</p>						

Con 6 guide With 6 rails	Code	Dim. esterne outside Dim. (mm)	Dim. interne inside Dim. (mm)	Peso weight (kg)	Vol (lt)	Colour
	TB7569R6	770×540×687	615×410×585	6,34	126	■
<p>Disponibili con 6 guide integrate stampate, per tenere in posizione in modo sicuro bacinelle e teglie 600×400 mm durante il trasporto. / The containers are available with 6 moulded built-in rails. The containers were designed to hold trays and 600×400 mm pans in position during transport, with no worries about spillage or loss.</p>						

Con 9 guide With 9 rails	Code	Dim. esterne outside Dim. (mm)	Dim. interne inside Dim. (mm)	Peso weight (kg)	Vol (lt)	Colour
	TB7569R9	770×540×687	615×410×585	6,60	126	■
<p>Disponibili con 9 guide integrate stampate, per tenere in posizione in modo sicuro bacinelle e teglie 600×400 mm durante il trasporto. / The containers are available with 9 moulded built-in rails. The containers were designed to hold trays and 600×400 mm pans in position during transport, with no worries about spillage or loss.</p>						

Termobox

Con guide regolabili
With adjustable rails

Code	Dim. esterne outside Dim. (mm)	Dim. interne inside Dim. (mm)	Peso weight (kg)	Vol (lt)	Colour
TB7569ADJR	770×540×687	615×410×585	8,17	155	■



Disponibile con 2 set di guide* regolabili in acciaio inossidabile per il trasporto di differenti contenitori, tra cui casse da 600×400 mm, bacinelle e teglie da forno nella stessa unità. / This exclusive multi-use container was designed with 2 sets of adjustable rails* in stainless steel enabling the operator to transport various containers including 600x400 mm crates, trays and baking pans in the same unit.

* Guide aggiuntive possono essere acquistate separatamente. Vedere gli accessori.
* Additional rails may be purchased separately. See the accessories.

Per bacinelle GN 1/1 con 8
guide / For GN 1/1 holdings
with 8 rails

Code	Dim. esterne outside Dim. (mm)	Dim. interne inside Dim. (mm)	Peso weight (kg)	Vol (lt)	Colour
TB6448	640×440×475	535×330×370	3,20	60	■



Per bacinelle GN 1/1 con 12
guide / For GN 1/1 holdings
with 12 rails

Code	Dim. esterne outside Dim. (mm)	Dim. interne inside Dim. (mm)	Peso weight (kg)	vol (lt)	Colour
TB6463	640×440×625	535×330×525	3,90	86	■



Accessori Accessories

Kit di guide regolabili /
Adjustable rails kit
per TB7569 / for TB7569

Code

Dimension
(mm)peso
weight (kg)

KITADJR

600×10×580

2,07



I telai in acciaio inossidabile e 2 set di guide per regolare e creare spazi personalizzati secondo necessità tra le guide. / The frames in stainless steel and the 2 sets of rails were designed to provide operators with the flexibility to adjust and create customized spaces between rails, according to their own needs.

Kit di guide / Rails kit
KITR per KITADJR /
KITR for KITADJR

Code

Dimension (mm)

Peso
weight (kg)

KITR

600×30×30

0,42



In acciaio inossidabile, può essere acquistato separatamente per trasportare più articoli nello stesso contenitore. / The kit made up of 2 adjustable rails in stainless steel may be purchased separately in order to transport various articles in the same container.

Carrelli / Trolleys

Code

CARE/P

per - for TB6426, TB6432, TB6432N

CARE75/I

per - for TB7527, TB7537

CARTB7569

per - for TB7569

CARTB6448-6463

per - for TB6448 e TB6463

Carrelli per impilare e trasportare diverse unità in una sola volta e in tutta sicure /
Trolleys for safely stacking and transporting various units as one operation.

Termobox

Piastre per freddo /
Icing boxes



Code

Dimension (mm)

Peso
weight (kg)

CP3226

325×265×30

1,75

CP5332

530×325×30

3,90

Progettate per prolungare il periodo di tempo durante il quale il cibo viene mantenuto freddo. Congelale in orizzontale per una notte e disponile in alto nel contenitore. / The icing boxes were designed to prolong the time of low-temperature storage of food. Freeze the icing box in a horizontal position for one night and then place it vertically in the container.

Piastre per caldo /
Eutectic plates



Code

Dimension (mm)

Peso
weight (kg)

HP5332

530×325×30

3,25

Progettate per prolungare il periodo di tempo durante il quale il cibo viene mantenuto caldo. Mettile in acqua calda per 35 minuti e disponile in fondo al contenitore. / The eutectic plates were designed to prolong the time of high-temperature storage of food. Submerge the plate in hot water for 35 minutes and then place it on the bottom of the container.

Etichette identificative /
Labels for identification



Code

IDL5

Etichette adesive colorate per la facile identificazione. Aiutano l'operatore a individuare e destinare l'uso del contenuto della scatola. / Coloured stickers provided to facilitate identification. Operators will find it easier to select container contents and their uses.

Ambassadors

MARIONA ES LA ENCARGADA
DEL PAN CON ACEITE Y SA

ole mote

SE

EUTR

WFA

1200

10

1000

+

100

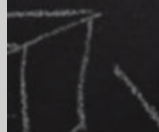

Soble mote

Caracul

operable







Pierre Hermé

Pasticceria *Pastry world*

Stampi per torte /
Cake moulds

Code	Name	Page
KE089 	Cylindra	108
KE090 	Cylindra	108

Stampi per monoporzioni /
Single-serving portions moulds

Code	Name	Page
PX4393 	Cylindra	43



Massimo Bottura

Cioccolateria *Chocolate world*

Serigrafie /
Silkscreen

Code	Name	Page
SD120SB	Camouflage	327
SD4COLSB	Camouflage	327



Jérôme De Oliveira

Pasticceria *Pastry world*

Stampi per monoporzioni /
Single-serving portions moulds

Code	Name	Page
PX43103	Easter mono	6

Stampi per torte /
Cake moulds

Code	Name	Page
KE094	Easter cake	7



Ramon Morató

Ciocolateria / Chocolate

Stampi per praline in tritan /
Tritan praline moulds





Code	Name	Page
PC5061	Cubo	12
PC5062	Cubo	12
PC5063	Cubo	12



Davide Oldani

Horeca

Stampi in silicone tridimensionali /
Three-dimensional silicone moulds

Code	Name	Page
GG068 	Half Apple	28
GG069 	Half Pear	29
GG070 	Half Lemon	30
GG071 	Half Orange	31
GG038	Gruyere	216
GG039	Cheese	216
GG040	Ricotta	217
GG041	Ossobuco	217
GG032	Scallop	218
GG033	Oyster	218
PX4338	Battuta d'inizio	219
PX4327	Battuta d'inizio	219
PX4328	Dama	219



Davide Comaschi

Ciocolateria *Chocolate world*

Stampi per tavolette / Choco bar moulds

Code	Name	Page
PC5051 	Maxi choco	262

Stampi tridimensionali / Three-dimensional moulds

Code	Name	Page
KT183	Abyss	278
KT205	Hexagon Tree	294
KT206	Blob Tree	295
KT207	Fluent Tree	294
KT194	Rocky Tree	294
KT208	Polaris	301

Stampi per praline / Praline moulds





Code	Name	Page
PC5040	Murano	248
PC5041	Murano	248
PC5042	Murano	248
PC5043	Murano	248
PC5044	Murano	248
PC5045	Murano	248
PC5046	Murano	248
PC5047	Murano	248
PC23	Innovation	253
PC50	Hearth Design	255
PC66	Abyss	259
PC67	Abyss	259
PC68	Abyss	259
PC69	Abyss	259



Cédric Grolet

Pasticceria *Pastry world*



Stampi per monoporzioni / Single-serving portions moulds

Code	Name	Page
PX43104 	Mango	16
PX43105 	Vanilla	17
PX43106 	Tablette	13
PX4397 	Bouquet de roses	43
PX4390	Je t'aime	44
PX4391	Charlotte	44
PX4392	Nuage	44
PX4388	Dentelle	45
PX4386	La vie en rose	45
PX4384	Façon Saint-Honoré	45
PX4359	Citron	46
PX4357	Marron	46
PX4358	Noisette	46
AF006	Citron	47
AF007	Marron	47
AF008	Noisette	47

Stampi per miniporzioni / Mini-portions moulds

Code	Name	Page
PX4399 	Façon Saint-Honoré	22

Stampi per torte / Cake moulds

Code	Name	Page
KE095 	Tablette	15
KE093 	Bouquet de roses	108
KE087	Charlotte	109
KE088	Nuage	109
KE086	Je t'aime	110
KE082	Dentelle	110
KE080	La vie en rose	111
KE074	Façon Saint-Honoré	111
KE057	Citron	112
KE056	Marron	112
KE055	Noisette	112



Emmanuele Forcone

Pasticceria *Pastry world*

Stampi per top / Top moulds

Code	Name	Page
TOP28 	Twirl	18
TOP29 	Twirl	19
TOP30 	Twirl	20
TOP07	Ipnosi	150
TOP05	Ipnosi	150
TOP06	Ipnosi	150
TOP08	River	151
TOP11	Mini River	151
TOP09	Coral	151
TOP10	Mini Coral	151
TOP15	Jelly	152
TOP16	Mini Jelly	152
TOP13	Shangai	152
TOP14	Mini Shangai	152
TOP01	Maya	153
TOP12	Mini Maya	153
TOP02	Sponge	153
TOP04	Circle	154
TOP03	Iceberg	154

Stampi per torte / Cake moulds

Code	Name	Page
KE075	Cadeau	113
KE076	Mini Cadeau	113
KE049S	Beloved	124
KE016	Passion	124
KE017	Passion	124
KE062	Cyclone	113
KE069S	Hula	114
KE070S	Corolla	114
KE071S	Louvre	114
KE024	Planet	115
KE052	Mini Planet	115
KE043	Mars	115
KE051	Mini Mars	115
KE013	Plissée	116
KE053	Mini Plissée	116

KE018	Queen	117
KE015	Bombée	116
KE054	Mini Bombée	116
KE032	Galaxy	117
KE019	Royal	117
KE042	Flip	118
KE027	Caleidon	118
KE030	Twister	118
KE025	Classic	119
KE026	Windy	119
KE028	Curvy	119
KE039	Honorè	120
KE044	Venus	120
KE023	Pop	120
KE029	Puffy	121
KE014	Petal	121
KE038	Rocky	121
KE047	Nevada	122
KE037	Square	122
KE031	Top	122
KE050	Ametista	123
KE068	Eros	123
KE034	Futura	123

Stampi per monoporzioni / Single-serving portions moulds

Code	Name	Page
PX4329	Pear	56
PX4330	Apple	56
PX4331	Peach / Cherry	56, 57
PX4332	Tangerine	57
PX4333	Strawberry	57
PX4370S	Beloved	58

Stampi per tronchetti / Logs moulds

Code	Name	Page
KE041	Atomic	138
KE033	Bilbao	138
KE040	Canyon	139
KE022	Crème	140
KE021	Sublime	140
KE035	Lady	140





Antonio Bachour

Pasticceria *Pastry world*

Stampi per torte / Cake moulds

Code	Name	Page
KE060	Lovely	124
KE061	Lovely	124

Stampi per miniporzioni / Mini-portions moulds

Code	Name	Page
PX43101 	Margherita	24
PX4398 	Jasmine	21

Stampi per medie porzioni / Medium portions moulds

Code	Name	Page
PX3221 	Muffin40time	26, 81
PX3215	Pastel40time	78
PX3216	Confy40time	78
PX3217	Cylinder40time	78
PX3218	Sphere40time	80
PX3219	Planet40time	80
PX3220	Cube40time	80

Stampi per monoporzioni / Single-serving portions moulds

Code	Name	Page
PX4363	Lovely	51
PX4383S	Margherita	49
PX4353S	Pastel	49
PX4375	Yoga	49
PX4376	Romance	50
PX4365	Tulip	50
PX4371	Lotus	51
PX4361	Tulum	51
PX4364	Gummy	52
PX4362	Gel	52
PX4360S	Miami	52

PX4356	Delish	53
PX4351S	Confy	53
PX4373	Domino	53
PX4374	Nautilus	50
PX4352S	Pelota	54
PX4340	Over	54
PX4341	Polly	54
PX4355	Jasmine	55

Cioccolateria *Chocolate world*

Stampi per praline / Praline moulds

Code	Name	Page
PC38	Bonbons	256
PC39	Bonbons	256
PC40	Bonbons	256
PC41	Bonbons	256
PC42	Bonbons	256
PC43	Bonbons	256
PC44	Bonbons	256
PC45	Bonbons	256
PC46	Bonbons	256
PC47	Bonbons	256
PC48	Bonbons	256
PC56	Bonbons	257
PC57	Bonbons	257
PC58	Bonbons	257
PC59	Bonbons	257
PC60	Bonbons	257
PC61	Bonbons	257
PC62	Bonbons	257
PC63	Bonbons	257
PC64	Bonbons	257
PC65	Bonbons	257

Stampi per tavolette / Choco bar moulds

Code	Name	Page
PC5000	Lovely	266



Stefano Laghi

Pasticceria *Pastry world*

Stampi per top / Top moulds

Code	Name	Page
TOP24	Raven	146
TOP20	Mini Raven	146
TOP27	Scarlet	147
TOP23	Mini Scarlet	147
TOP26	Almonds	148
TOP22	Mini Almonds	148
TOP25	Hazel	149
TOP21	Mini Hazel	149

Stampi sfere / Sphere moulds

Code	Name	Page
LS05	Pavoduo	94

Ciocolateria *Chocolate world*

Attrezzature per cioccolato / Chocolate equipment

Code	Name	Page
LS01	Chokoflex	343
LS02	Chokoflex	343
LS03	Chokoflex	343
LS04	Chokoflex	343
LS06	Chokoflex	343
LS07	Chokoflex	343
CH1	FlyChoc	340
CH2	FlyChoc	340
CH3	FlyChoc	340
CH4	FlyChoc	340
CH5	FlyChoc	340
CH6	FlyChoc	340
CH7	FlyChoc	340
CH8	FlyChoc	340
CH9	FlyChoc	340
CH10	FlyChoc	340



Johan Martin

Pasticceria *Pastry world*

Fasce inox /
Stainless steel bands

Code	Name	Page
XF51	Viennoiserie	184, 185
XF52	Viennoiserie	184, 185
XF53	Viennoiserie	184, 186
XF54	Viennoiserie	184, 186
XF55	Viennoiserie	184, 187
XF56	Viennoiserie	184, 187
XF57	Viennoiserie	184, 188



Nicolas Bacheyre

Pasticceria *Pastry world*

Stampi per monoporzioni /
Single-serving portions moulds

Code	Name	Page
PX3214S	Slake	72



Fabrizio Fiorani

Cioccolateria *Chocolate world*

Stampi per tavolette / Choco bar moulds

Code	Name	Page
PC5058 	Xmas spirit	264
PC5059 	Xmas night	264
PC5060 	Halloween Friends	263
PC5048	Easter Bunny	263
PC5049	Easter Friends	263
PC5037	Bubble Tree	264
PC5038	Xmas Village	265
PC5039	Xmas Friends	265
PC5010	Bricks	267
PC5011	Camouflage	266
PC5012	Pixie	267
PC5013	Mini Bricks	267
PC5001	Sparkling	265
PC5002	Crush	268
PC5003	Ola	268

Stampi per praline / Praline moulds

Code	Name	Page
PC49	Iconic	258
PC51	Iconic	258
PC52	Iconic	258
PC53	Iconic	258
PC55	Iconic	258

Pasticceria *Pastry world*

Stampi per monoporzioni / Single-serving portions moulds

Code	Name	Page
PX4394 	Lampone 1.1	61

Horeca

Stampi in silicone tridimensionali / Three-dimensional silicone moulds

Code	Name	Page
GG066	Mini Coffee	27
GG052	Balloon	229



Gianluca Fusto

Pasticceria *Pastry world*

Stampi per monoporzioni / Single-serving portions moulds

Code	Name	Page
PX4335S	Square	59
PX4337S	Rectangular	59
PX4334S	Round	60
PX4336S	Oval	60
PX3200	Round	73
PX3201	Shell	73
PX3202	Cameo	73
PX3203	Spring	73
PX3204	Sand	74
PX3205	Pyramid	74
PX3206	Heart	74
PX3207	Rock	74
PX3208	Frisbee	75
PX3209	Charm	75
PX3210	Step	75
PX3211	Pill	75

Stampi per top / Top moulds

Code	Name	Page
TOP17	Frisbee	155
TOP18	Frisbee	155
TOP19	Frisbee	155

Fasce inox / Stainless steel bands





Fasce inox microforate per crostate, da pag 179
a pag 182 / Micro-perforated rings for tarts, from
page 179 to page 182



Paolo Griffa

Horeca

Tappetini in silicone per decorazioni / Silicone mats for decorations

Code	Name	Page
GG072 	Me&You	33
GG073 	Optique	32
GG074 	Garden	34
GG075 	Floreale	35
GG067 	Honey pattern	36
GG059	Mosaic Frame	236
GG060	Foliage Frame	164, 236
GG061	Jasmine Frame	237
GG062	Blade Frame	237
GG063	Mandala	238
GG064	Honey Bees	239
GG065	Snowflake	239
GG027	Coral	240
GG028	Plume	164, 241
GG029	Leaf	241
GG030	Bonsai	241
GG031	Wood	242

Stampi in silicone tridimensionali / Three-dimensional silicone moulds

Code	Name	Page
GG001	Anello piccolo	230
GG002	Anello grande	230
GG003	Disco grande	231
GG004	Disco piccolo	231
GG005	Spirale	231
GG006	Tondo	232
GG007	Ovale	232
GG008	Triangolo	232
GG009	Spirale triangolo	233
GG010	Spirale ovale	233
GG047	Honeycomb	165, 240
GG048	Oak tree	164, 242
GG049	Maple	242
GG050	Mariposa	165, 243
GG051	Mariposa	165, 243



Felix Lo Basso

Horeca

Stampi in silicone tridimensionali /
Three-dimensional silicone moulds

Code	Name	Page
GG011	Chestnut	167, 222
GG012	Olive	223
GG013	Almond	166, 223
GG014	Peanut	167, 223
GG015	Nutshell	167, 224
GG016	Cherry	166, 224
GG017	Berry	166, 224
GG024	Mandarin	165, 225
GG025	Mushroom	225
GG026	Nut	225
GG018	Puzzle	227
GG022	Gravel	227
GG019	Stones	227
GG023	Tree	228
GG020	Ovosquare	228
GG021	Triaround	228



Franco Aliberti

Horeca

Stampi in silicone tridimensionali /
Three-dimensional silicone moulds

Code	Name	Page
GG055	Melanzana	220
GG056	Carciofo	220
GG057	Cuore di bue	220
GG058	Friggitello	221
GG034	Asparagus	221
GG046	Carrot	221



Maurizio Santin

Pasticceria *Pastry world*

Stampi per torte /
Cake moulds

Code	Name	Page
KE058	Disco	125



Andrea Berton

Horeca

Stampi in silicone tridimensionali /
Three-dimensional silicone moulds

Code	Name	Page
GG054	Egg	226



Eunji Lee

Horeca

Stampi in silicone tridimensionali /
Three-dimensional silicone moulds

Code	Name	Page
GG035	Baby banana	226



Giuseppe Amato

Pasticceria *Pastry world*

Stampi per monoporzioni /
Single-serving portions moulds

Code	Name	Page
PX4377S	Sfogliatella	55

Stampi per miniporzioni /
Mini-portions moulds

Code	Name	Page
PX4378	Sfogliatella	84



Silvia Federica Boldetti

Pasticceria *Pastry world*

Attrezzature e stampi per gelato /
Ice cream Equipments and moulds

Code	Name	Page
PX3212S	Rainbow stick	206



Sebastiano Caridi

Pasticceria *Pastry world*

Stampi per top /
Top moulds

Code	Name	Page
TOP24	Raven	146
TOP20	Mini Raven	146
TOP27	Scarlet	147
TOP23	Mini Scarlet	147
TOP26	Almonds	148
TOP22	Mini Almonds	148
TOP25	Hazel	149
TOP21	Mini Hazel	149



Karim Bourgi

Pasticceria *Pastry world*

Stampi per torte /
Cake moulds

Code	Name	Page
KE065	Squeeze	125

Stampi per tronchetti /
Logs moulds

Code	Name	Page
KE045	Coin	139



Leonardo Di Carlo

Pasticceria *Pastry world*

Formasil

Code	Name	Page
FF4306	Formasil	170
FF4301	Formasil	170
FF4308	Formasil	170
FF4311	Formasil	170
FF06	Formasil	172
FF01	Formasil	172
FF08	Formasil	172
FF09	Formasil	172
FF11	Formasil	173
FF10	Formasil	173
FF12	Formasil	173
FF03	Formasil	174
FF04	Formasil	174
FF02	Formasil	174
FF05	Formasil	174

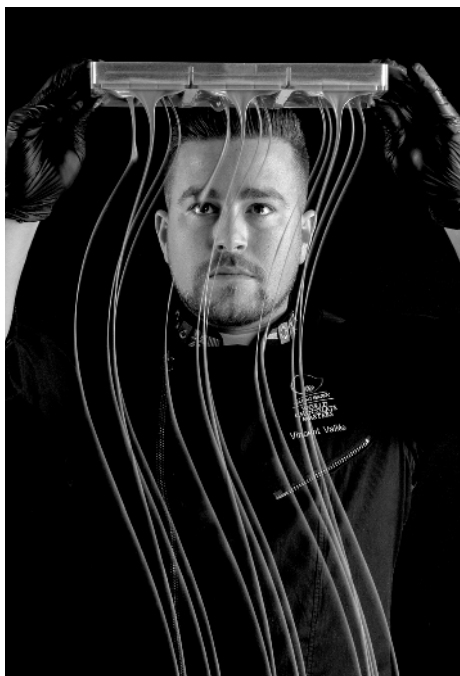

Vincent Vallée

Ciocolateria *Chocolate world*

Stampi per tavolette /
Choco bar moulds

Code	Name	Page
PC5029	Hexa	268
PC5030	Fluid	269
PC5014	Mini Moulin	269
PC5009	Moulin	269
PC5004	Fragment	270
PC5005	Edelweiss	271
PC5006	Pavé	271
PC5007	Flow	270
PC5008	Target	270

Stampi tridimensionali per cioccolato /
Three-dimensional chocolate moulds

Code	Name	Page
KT196	Flow	276



Festività
Celebration



Pasqua Easter

Code	Page	Code	Page	Code	Page
KE094	7	KT185	289	KT74	284
KT129	287	KT186	277	KT76	284
KT130	282	KT187	277	KT77	284
KT131	290	KT188	277	KT78	286
KT138	279	KT189	290	KT79	286
KT139	279	KT190	278	KT90	285
KT140	282	KT195	276	KT91	285
KT142	291	KT196	276	KT92	285
KT143	291	KT197	276	PC5048	263
KT154	290	KT198	288	PC5049	263
KT155	291	KT203	275	PX43103	6
KT156	281	KT204	275	SD226SB	323
KT157	279	KT209	274	T1022SB	312
KT158	288	KT210	274	T1023SB	312
KT167	288	KT211	274	T1024SB	312
KT168	281	KT212	275	T1025SB	313
KT169	287	KT216	8	T1026SB	313
KT170	289	KT217	9	T1027SB	313
KT172	277	KT218	10	T1028SB	313
KT173	282	KT50	283	T1029SB	313
KT174	281	KT51	283	T1030SB	313
KT182	278	KT70	283	T1031SB	313
KT183	278	KT71	287	T1032SB	313
KT184	289	KT72	286		

Natale Christmas

Code	Page	Code	Page	Code	Page
GIRATU150	390	KT127	306	KT20	295
GIRATU200	390	KT133	304	KT200	298
GIRATU225	390	KT135	297	KT201	301
GIROIOP	391	KT136	295	KT202	301
GIROIOP	391	KT137	297	KT205	294
KE011	141	KT148	302	KT206	295
KE012	141	KT149	305	KT207	294
KE021	141	KT150	299	KT208	301
KE022	141	KT151	299	KT213	293
KE033	138	KT152	297	KT214	293
KE035	141	KT153	306	KT215	292
KE040	139	KT16	295	KT86	304
KE041	138	KT162	296	KT87	306
KE045	139	KT163	300	PC5037	264
KE046	139	KT164	300	PC5038	265
KE066	137	KT165	305	PC5039	265
KE067	138	KT166	302	PC5058	264
KE072	137	KT175	300	PC5059	264
KE073	137	KT176	296	PX059	140
KE077	136	KT177	296	PX083	65
KE078	136	KT178	299	PX4389	48
KE079	136	KT179	303	PX4395	42
KE084	135	KT180	303	PX4396	42
KE085	135	KT181	303	PZ20SB	317
KE091	134	KT191	298	SD221SB	322
KE092	134	KT192	298	SD223SB	322
KT120	304	KT193	302	SD231SB	322
KT122	305	KT194	294	SD232SB	322
KT125	300	KT199	298	T1000SB	315

Code	Page
T1001SB	315
T1002SB	315
T1003SB	315
T1004SB	315
T1005SB	316
T1006SB	316
T1007SB	316
T1009SB	316
T1010SB	316

Code	Page
T1011SB	316
T1012SB	316
T1013SB	317
T1014SB	317
T1015SB	317
T1016SB	317
T1017SB	317
T1018SB	317
T1033SB	314

Code	Page
T1034SB	314
T1035SB	314
T1036SB	315
TX01	142
TX02	142
TX03	142
TX04	142

Love

Code	Page
KE016	124
KE017	124
KE049S	124
KE060	124
KE061	124
KE068	123
KE075	113
KE076	113
KE083	135
KE086	110
KE093	108

Code	Page
MM14	255
PC17	254
PC50	255
PC5000	266
PC5026	252
PC5028	266
PR007	158
PR008	158
PR009	158
PX4305	58
PX4325	84

Code	Page
PX4363	51
PX4370S	58
PX4385	48
PX4390	44
PX4397	43
SD224SB	323
SD225SB	323
SD233SB	323
SD234SB	323
SD235SB	323

Halloween

Code	Page
PC5060	263



1000

1000

1000

1000

1000

1000

1000

1000

1000

1000

Silicone

Il silicone in pasticceria Silicone in pastry

Nella realizzazione dei prodotti in silicone utilizziamo sempre ed esclusivamente silicone platinico al 100%, secondo le normative UE. È atossico, inodore, insapore e sicuro anche a temperature molto elevate. Con una qualità che permette di mantenere altissima la performance dei prodotti e che garantisce ai nostri clienti articoli efficaci e resistenti. / We always and exclusively use 100% platinum silicone for our products, according to EU regulations. It is non-toxic, odourless, tasteless and safe even at very high temperatures. With a quality that allows us to keep a very high performance and guarantees our customers effective and durable items.

I suoi vantaggi Advantages



Atossico, inodore e insapore /
Non-toxic, odourless and tasteless

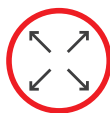

Flessibile e salvaspazio /
Flexible and space-saving



Infrangibile, resistente e stoccabile /
Unbreakable, durable and storable

Consigli Tips

- Lava i tuoi stampi in lavastoviglie senza utilizzare prodotti abrasivi o detergenti aggressivi. / Wash your moulds in the dishwasher without using abrasive products or harsh detergents.
- Non usare coltelli a contatto con lo stampo. / Do not use knives in contact with the mould.
- Non posizionare lo stampo su fonti di calore dirette (fuoco, grill, vetroceramica e piastra elettrica). / Do not place the mould on direct heat sources (fire, grill, ceramic glass or electric plate).
- Non utilizzare la funzione CRISP nel microonde. / Do not use the CRISP function in the microwave.

Rispetta questi suggerimenti: i tuoi stampi Pavoni Italia sono pronti per migliaia di utilizzi! / Respect these tips: your Pavoni Italia moulds are ready for thousands of uses!

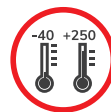

Efficace da -40°C a +250°C /
Valid from -40°C to +250°C







Versatile - da abbattitore a forno senza attese e viceversa /
Versatile - from blast chiller to oven without waiting and vice versa



Lavabile in lavastoviglie /
Dishwasher safe

Indice alfabetico / Alphabetical index

Code	Page	Code	Page	Code	Page	Code	Page
14010	395	131/18	397	BB30	400	CHT	404
14020	395	131/20	397	BB35	400	CIOCOPLASTBN	362
14030	395	131/22	397	BB4	400	CIOCOPLASTMR	362
14040	395	133/20	397	BB45	400	CIOCOPLASTWH	363
14050	395	133/25	397	BB5	400	CLN01SB	352
14060	395	133/30	397	BB55	400	CLN02SB	352
14070	395	133/35	397	BB6	400	CLN04SB	352
14080	395	133/40	397	BOTTIGLIA	410	CLN05SB	352
14090	395	40A	397	BR102	335	CLN06SB	352
34013	395	40B	397	BR108	334	CLN07SB	352
34063	413	40C	397	BR109	334	CLN08SB	352
43753	413	41A	397	BR147	334	CLN09SB	352
43763	413	41B	397	BR148	334	CLN10SB	352
125/10	396	41C	397	BR149	335	CLN11SB	352
125/12	396	A01SB	348	BRILLSPRAY	365	CM64095	406
125/14	396	A02SB	348	CAG05	411	CM64100	406
125/16	396	A03SB	348	CAG1	411	CM64105	406
125/18	396	A04SB	348	CAG2	411	CM64110	406
125/2	396	A05SB	348	CAG3	411	CM67777	406
125/20	396	A06SB	348	CAG5	411	CM67781	406
125/4	396	A07SB	348	CANNELLO	416	CM67785	406
125/6	396	A08SB	348	CARAMELLOMETRO	416	CM67791	406
125/8	396	A09SB	348	CARCAM	427	CM67793	406
126/10	396	A10SB	348	CARCL	427	CMCS	402
126/12	396	A11SB	348	CARGP150	390	CMES	402
126/14	396	AEROGRAFO	415	CARGP200	390	CMGS	402
126/16	396	AEROPENNA	415	CARGP225	390	CMOS	402
126/18	396	AF001	94	CARRELO PER FORNO	424	CMQS	402
126/2	396	AF002	94	CARRELO PORTA MARNE	424	CMRS	402
126/20	396	AF003	94	CB09	425	CMTNS	402
126/4	396	AF004	94	CB16	425	CMTRS	402
126/6	396	AF005	94	CB25	425	CMTS	402
126/8	396	AF006	47	CB36	425	CMVS	402
127/10	396	AF007	47	CB49	425	COLINO	411
127/12	396	AF008	47	CBP	425	COS	401
127/14	396	AGAR AGAR	367	CBU	425	COVER55	387
127/16	396	ALADIN	417	CBV	425	COVER85	387
127/18	396	AP1	412	CBVA	425	CPAZ250	363
127/2	396	ARGENTO	358	CCS	401	CPBN250	363
127/20	396	ARGENTOPV	358	CCOP	426	CPCO250	363
127/4	396	ARGENTOSC1	358	CES	401	CPG250	363
127/6	396	B134	334	CGS	401	CPGL250	363
127/8	396	B139	334	CH1	340	CPN250	363
128/10	397	B159	334	CH10	340	CPR250	363
128/12	397	B161	334	CH2	340	CPRA250	363
128/14	397	B162	334	CH3	340	CPV250	363
128/16	397	B163	335	CH4	340	CPVL250	363
128/18	397	B167	334	CH5	340	CPVS250	363
128/2	397	B181	334	CH6	340	CPOS	426
128/20	397	B197	335	CH7	340	CQS	401
128/4	397	B204	334	CH8	340	CRO9	426
128/6	397	B702	335	CH9	340	CR16	426
128/8	397	B705	334	CHC	404	CR25	426
131/10	397	B707	334	CHELATBL CHEF	414	CR36	426
131/12	397	B708	335	CHO	404	CR49	426
131/14	397	BAZ	416	CHOCOICE	365	CRS	401
131/16	397	BB25	400	CHQ	404	CRU	426

Code	Page	Code	Page	Code	Page	Code	Page
CTNS	401	DV2SB	346	FOROSILGASTRO 1/1 	376	FR074	102
CTRS	401	DV3SB	346	FR001	98	FR075	102
CTS	401	DV4SB	346	FR002	98	FR076	102
CV1 	5	DV5SB	346	FR003	98	FR077	102
CV2 	5	DV6SB	346	FR004	98	FR078	103
CV3 	5	DV7SB	346	FR005	98	FR082	103
CVS	401	DV8SB	346	FR006	98	FR096	103
D25QR	337	DV9SB	346	FR007	98	FR103	103
D25T	337	EASYAZ	359	FR008	98	FR116	103
D35C	337	EASYBL	359	FR009	98	FRT001	104
D35T	337	EASYBN	359	FR010	98	FRT002	104
D38TR	337	EASYN	359	FR011	98	FRT003	104
D3C	337	EASYR	359	FR012	98	FRT004	104
D3T	337	ECL20	378	FR013	99	FRT005	104
D40-O	337	ECL48	378	FR014	99	FRT051	105
D45-O	337	ECS	401	FR015	99	FRT052	105
D4QR	337	EES	401	FR016	99	FRT053	105
D4T	337	EGS	401	FR017	99	FRT058	105
D51R	337	EMCS	402	FR018	99	FRT077	105
D52R	337	EMES	402	FR019	99	FRT103	105
DCR	404	EMGS	402	FR020	99	FRT104	105
DECOTAB	359	EMOS	402	FR021	99	FRT106L	105
DECOTABAZ	360	EMQS	402	FR022	99	FRT120	105
DECOTABBL	360	EMRS	402	FR023	99	FT250FPC	392
DECOTABBN	360	EMTNS	402	FR024	99	FT350FPC	392
DECOTABCO	360	EMTS	402	FR025	100	FT450FPC	392
DECOTABFU	360	EMVS	402	FR026	100	GG001	230
DECOTABG	360	EOS	401	FR027	100	GG002	230
DECOTABN	360	EQS	401	FR028	100	GG003	231
DECOTABR	360	ERS	401	FR029	100	GG004	231
DECOTABRA	360	ETS	401	FR030	100	GG005	231
DECOTABRC	360	EVS	401	FR031	100	GG006	232
DECOTABVC	360	FA64	399	FR032	100	GG007	232
DECOTABVS	360	FCH34	399	FR033	100	GG008	232
DS01	342	FCH64	399	FR034	100	GG009	233
DS02	342	FF01	172	FR035	100	GG010	233
DTAR250	361	FF02	174	FR036	100	GG011	222
DTAZ250	361	FF03	174	FR037	101	GG012	223
DTBL250	361	FF04	174	FR038	101	GG013	223
DTBN250	361	FF05	174	FR039	101	GG014	223
DTCO250	361	FF06	172	FR040	101	GG015	224
DTFU250	361	FF08	172	FR041	101	GG016	224
DTG250	361	FF09	172	FR045	101	GG017	224
DTGL250	361	FF10	173	FR046	101	GG018	227
DTGU250	361	FF11	173	FR047	101	GG019	227
DTN250	361	FF12	173	FR048	101	GG020	228
DTR250	361	FF13	175	FR049	101	GG021	228
DTRA250	361	FF4301	170	FR050	101	GG022	227
DTRC250	361	FF4303	170	FR052	101	GG023	228
DTV250	361	FF4306	170	FR053	102	GG024	225
DTVL250	361	FF4308	170	FR056RSA	102	GG025	225
DTVS250	361	FF4311	170	FR064	102	GG026	225
DV12SB	346	FF4313	175	FR065	102	GG027	240
DV14SB	346	FLAME	417	FR068	102	GG028	241
DV15SB	346	FOROSIL43	378	FR069	102	GG029	241
DV17SB	346	FOROSIL53	378	FR071	102	GG030	241
DV1SB	346	FOROSIL64	378	FR073	102	GG031	242

Code	Page	Code	Page	Code	Page	Code	Page
GG032	218	IMB8	411	KE022	140	KE082	110
GG033	218	IN140	372	KE023	120	KE083	135
GG034	221	IN160	372	KE024	115	KE084	135
GG035	226	IN180	372	KE025	119	KE085	135
GG036	222	IN200	372	KE026	119	KE086	110
GG037	222	IN220	372	KE027	118	KE087	109
GG038	216	ISOMALTO	364	KE028	119	KE088	109
GG039	216	ISOMALTOKG1	364	KE029	121	KE089	108
GG040	217	ISOMALTOKG5	364	KE030	118	KE090	108
GG041	217	ISOPAV500	364	KE031	122	KE091	134
GG046	221	JF04030D20P00G	420	KE032	117	KE092	134
GG047	240	JF04030D20P00V	420	KE033	138	KE093	108
GG048	242	JF06040D20P00G	420	KE034	123	KE094	7
GG049	242	JF06040D20P00V	420	KE035	140	KE095	15
GG050	243	JF08060D20P00G	420	KE036	126	KE997	104
GG051	243	JF08060D20P00V	420	KE037	122	KE998	104
GG052	229	JH04030D20P00G	420	KE038	121	KE999	104
GG053	226	JH04030D30P00G	420	KE039	120	KITPL01	202
GG054	226	JH05030D20P00G	420	KE040	139	KITPL02	202
GG055	220	JH06040D20P00G	420	KE041	138	KITPL03	203
GG056	220	JH06040D20P00V	421	KE042	118	KITPL04	203
GG057	220	JH06040D30P00G	420	KE043	115	KITPL05	203
GG058	221	JH06040D40P00G	420	KE044	120	KITPL06	204
GG059	236	JH08060D20P00G	420	KE045	139	KITPL07	204
GG060	236	JS04030D20P00G	421	KE046	139	KITPL08	204
GG061	237	JS04030D20P00V	421	KE047	122	KITPL09	204
GG062	237	JS06040D10P00G	421	KE049S	124	KITPL10	205
GG063	238	JS06040D10P00V	421	KE050	123	KITPL11	205
GG064	239	JS06040D20P00G	421	KE051	115	KITPL12	205
GG065	239	JS06040D20P00V	421	KE052	115	KITPL13	202
GG066	27	JS06040D30P00G	421	KE053	116	KS26	385
GG067	36	JS06040D30P00V	421	KE054	116	KS30	319
GG068	28	JS06040D40P00G	421	KE055	112	KS32	385
GG069	29	JS06040D40P00V	421	KE056	112	KS47	207
GG070	30	JS08060D20P00G	421	KE057	112	KS48	207
GG071	31	JS08060D20P00V	421	KE058	125	KS50	271
GG072	33	KE001	127	KE060	124	KS51	385
GG073	32	KE002	127	KE061	124	KSSUP	207
GG074	34	KE003	127	KE062	113	KT50	283
GG075	35	KE004	128	KE063	126	KT51	283
GIRATU150	390	KE005	128	KE064	126	KT70	283
GIRATU200	390	KE006	128	KE065	125	KT71	287
GIRATU225	390	KE007	129	KE066	137	KT72	286
GIROIO G	391	KE008	129	KE067	138	KT74	284
GIROIO P	391	KE009	129	KE068	123	KT76	284
GLA64	398	KE010	130	KE069S	114	KT77	284
GOMMA XANTHANO	367	KE011	141	KE070S	114	KT78	286
GREENMATIC12	419	KE012	141	KE071S	114	KT79	286
GREENMATIC25	419	KE013	116	KE072	137	KT86	304
GRIGLIA26	427	KE014	121	KE073	137	KT87	306
GRIGLIA32	427	KE015	116	KE074	111	KT90	285
GUANTO/A	414	KE016	124	KE075	113	KT91	285
HYFOAMA	367	KE017	124	KE076	113	KT92	285
IMB10	411	KE018	117	KE077	136	KT16	295
IMB12	411	KE019	117	KE078	136	KT20	295
IMB14	411	KE020	117	KE079	136	KT120	304
IMB18	411	KE021	140	KE080	111	KT122	305

Code	Page	Code	Page	Code	Page	Code	Page
KT123	308	KT191	298	LL01SB	352	P002/335	331
KT125	300	KT192	298	LL02SB	352	P003/108	332
KT127	306	KT193	302	LL07SB	352	P004/105	331
KT129	287	KT194	294	LL08SB	352	P005/065	331
KT130	282	KT195	276	LL10SB	352	P011	332
KT131	290	KT196	276	LL11SB	352	P012	332
KT133	304	KT197	276	LS01	343	P012/365	331
KT135	297	KT198	288	LS02	343	P020	332
KT136	295	KT199	298	LS03	343	P021/127	331
KT137	297	KT200	298	LS04	343	P023/135	332
KT138	279	KT201	301	LS05	94	P030	332
KT139	279	KT202	301	LS06	343	P037	332
KT140	282	KT203	275	LS07	343	P041/136	331
KT142	291	KT204	275	M01SB	350	P048	332
KT143	291	KT205	294	M02SB	350	P053	332
KT146	308	KT206	295	M03SB	350	P056	332
KT148	302	KT207	294	M04SB	350	P057/131	332
KT149	305	KT208	301	M07SB	350	P073	331
KT150	299	KT209	274	M08SB	350	P074	332
KT151	299	KT210	274	MACARONBN	365	P075	332
KT152	297	KT211	274	MACARONRA	365	P078	331
KT153	306	KT212	275	MAGICDECOR	366	P096	332
KT154	290	KT213	293	MAGICDECOR250	366	P109	331
KT155	291	KT214	293	MAGICDECOR3	366	P110	331
KT156	281	KT215	292	MASSAPAVONISUMMER	362	P115	332
KT157	279	KT216	8	MC36	386	P150	331
KT158	288	KT217	9	MM11	255	P156	332
KT159	307	KT218	10	MM12	255	P157	331
KT160	307	KTDALLAH	308	MM13	255	P168	332
KT162	296	KTMATRIOSKA	307	MM14	255	P170	331
KT163	300	L01SB	349	NC01	354	P203	331
KT164	300	L02SB	349	NC02	354	P204	331
KT165	305	L03SB	349	NC03	354	P205	331
KT166	302	L04SB	349	NC04	354	P216	331
KT167	288	L05SB	349	NC05	354	P219	332
KT168	281	L06SB	349	NC06	354	P332	332
KT169	287	L07SB	349	NC07	354	P339	332
KT170	289	L08SB	349	NC08	354	P348	332
KT172	277	L09SB	349	NC09	354	P397	331
KT173	282	L10SB	349	NC10	354	P417	331
KT174	281	L11SB	349	NC11	354	P418	331
KT175	300	L12SB	349	NCP01	355	P428	332
KT176	296	LAMPADA	416	NCP02	355	P468	332
KT177	296	LB01SB	351	NCP03	355	P521	331
KT178	299	LB02SB	351	NCP04	355	PASTAMICA	361
KT179	303	LB03SB	351	NCP05	355	PAVOCOOKIE	207
KT180	303	LB04SB	351	NCP06	355	PAVOGEL	207
KT181	303	LB05SB	351	NCP07	355	PB12	398
KT182	278	LB06SB	351	NCP08	355	PB24	398
KT183	278	LB07SB	351	NCP09	355	PC01	253
KT184	289	LB08SB	351	NCP10	355	PC02	253
KT185	289	LB09SB	351	NIDODAPE	404	PC03	253
KT186	277	LB10SB	351	ORO	358	PC04	253
KT187	277	LB11SB	351	OROPV	358	PC05	253
KT188	277	LB12SB	351	OROSC1	358	PC06	253
KT189	290	LB14SB	351	PALA35	410	PC07	253
KT190	278	LB15SB	351	PALA57	410	PC08	253

Code	Page	Code	Page	Code	Page	Code	Page
PC09	253	PC109	251	PC5063	12	PR005	160
PC10	253	PC110	251	PCT	418	PR006	160
PC11	254	PC111	251	PECTINA	367	PR007	161
PC12	254	PC112	252	PETTINE	418	PR008	161
PC13	254	PC113	251	PF1	403	PR009	161
PC14	254	PC114	251	PF10	403	PT01SB	356
PC15	254	PC115	251	PF10A	403	PT02SB	356
PC16	254	PC5000	266	PF11	403	PT03SB	356
PC17	254	PC5001	265	PF12	403	PT04SB	356
PC18	254	PC5002	268	PF13	403	PT05SB	356
PC19	254	PC5003	268	PF14	403	PVF0600400	400
PC20	254	PC5004	270	PF15	403	PW040	394
PC21	254	PC5005	271	PF18	403	PW045	394
PC22	254	PC5006	271	PF2	403	PW050	394
PC23	253	PC5007	270	PF2A	403	PX001	67
PC36	253	PC5008	270	PF3	403	PX002	71
PC37	254	PC5009	269	PF300	403	PX003	68
PC38	256	PC5010	267	PF3A	403	PX004	68
PC39	256	PC5011	266	PF4	403	PX005	69
PC40	256	PC5012	267	PF4A	403	PX006	89
PC41	256	PC5013	267	PF5	403	PX007	70
PC42	256	PC5014	269	PF5A	403	PX010	70
PC43	256	PC5015	250	PF6	403	PX011	88
PC44	256	PC5016	250	PF6A	403	PX012	88
PC45	256	PC5017	250	PF7	403	PX013	88
PC46	256	PC5018	250	PF7A	403	PX014	69
PC47	256	PC5019	250	PF8	403	PX015	69
PC48	256	PC5020	250	PF8A	403	PX016	67
PC49	258	PC5021	250	PF9	403	PX017	87
PC50	255	PC5022	250	PG7	410	PX018	68
PC51	258	PC5023	250	PG7TR	410	PX019	70
PC52	258	PC5024	250	PG8	410	PX020	88
PC53	258	PC5026	252	PILLY4	422	PX021	70
PC55	258	PC5027	252	PL01	202	PX022	88
PC56	257	PC5028	266	PL02	202	PX023	67
PC57	257	PC5029	268	PL03	203	PX024	67
PC58	257	PC5030	269	PL04	203	PX025	69
PC59	257	PC5033	252	PL05	203	PX026	71
PC60	257	PC5037	264	PL06	204	PX027	70
PC61	257	PC5038	265	PL07	204	PX029	69
PC62	257	PC5039	265	PL08	204	PX030	68
PC63	257	PC5040	248	PL09	204	PX032	66
PC64	257	PC5041	248	PL10	205	PX033	71
PC65	257	PC5042	248	PL11	205	PX034	67
PC66	259	PC5043	248	PL12	205	PX035	69
PC67	259	PC5044	248	PL13	202	PX036	70
PC68	259	PC5045	248	PM54129	406	PX039	65
PC69	259	PC5046	248	PM54130	406	PX040	68
PC100	251	PC5047	248	PM64005	406	PX041	71
PC101	251	PC5048	263	PM64010	406	PX042	70
PC102	251	PC5049	263	PM64012	406	PX043	88
PC103	252	PC5051	262	PM64025	406	PX044	88
PC104	252	PC5058	264	POMPETTA	416	PX045	87
PC105	252	PC5059	264	PR001	159	PX046	87
PC106	251	PC5060	263	PR002	159	PX047	87
PC107	251	PC5061	12	PR003	159	PX048	88
PC108	251	PC5062	12	PR004	160	PX051	68

Code	Page	Code	Page	Code	Page	Code	Page
PX052	68	PX4303	63	PX4365	50	RM16	406
PX054	69	PX4304	62	PX4369	58	RM18	406
PX055	69	PX4305	58	PX4370S	58	RM20	406
PX056	71	PX4306	63	PX4371	51	RM22	406
PX057	70	PX4307	62	PX4372	62	RM24	406
PX058	66	PX4308	62	PX4373	53	RM28	406
PX059	140	PX4310	143	PX4374	50	RP1	409
PX060	66	PX4312	63	PX4375	49	RP2	409
PX061	131	PX4313	93	PX4376	50	RP3	409
PX063	68	PX4314	93	PX4377S	55	RP4	409
PX064	66	PX4315	93	PX4378	84	RP5	409
PX065	67	PX4316	93	PX4382S	55	RT40S	393
PX066	67	PX4317	62	PX4383S	49	RT55S	393
PX067	67	PX4318	143	PX4384	45	RT65S	393
PX068	66	PX4319	143	PX4385	48	S01SB	350
PX070	71	PX4320	143	PX4386	45	S02SB	350
PX071	66	PX4321	62	PX4387	48	S03SB	350
PX072	87	PX4322	62	PX4388	45	S04SB	350
PX073	66	PX4323	86	PX4389	48	SALI DI SILICIO	367
PX074	87	PX4324	85	PX4390	44	SCARPADECOLTE	309
PX075	131	PX4325	84	PX4391	44	SCIROPPO DI GLUCOSIO	367
PX076	131	PX4326	85	PX4392	44	SD120SB	327
PX077	131	PX4327	219	PX4393	43	SD200SB	324
PX078	66	PX4328	219	PX4394	61	SD201SB	324
PX079	87	PX4329	56	PX4395	42	SD202SB	324
PX083	65	PX4330	56	PX4396	42	SD203SB	325
PX300	89	PX4331	56, 57	PX4397	43	SD204SB	325
PX301	89	PX4332	57	PX4398	21	SD205SB	325
PX302	87	PX4333	57	PX4399	22	SD206SB	325
PX303	86	PX4334S	60	PX43100	23	SD207SB	325
PX304	86	PX4335S	59	PX43101	24	SD208SB	325
PX305	89	PX4336S	60	PX43102	25	SD209SB	325
PX306	89	PX4337S	59	PX43103	6	SD210SB	325
PX307	71	PX4338	219	PX43104	16	SD211SB	326
PX3200	73	PX4339	93	PX43105	17	SD212SB	326
PX3201	73	PX4340	54	PX43106	13	SD213SB	326
PX3202	73	PX4341	54	PZ20SB	317	SD214SB	326
PX3203	73	PX4342	62	RA10RS	405	SD215SB	326
PX3204	74	PX4343	63	RA1RS	405	SD216SB	326
PX3205	74	PX4345	63	RA2RS	405	SD217SB	326
PX3206	74	PX4346	84	RA3RS	405	SD218SB	326
PX3207	74	PX4348	85	RA4RS	405	SD219SB	327
PX3208	75	PX4349	61	RA5RS	405	SD220SB	327
PX3209	75	PX4350	93	RA6RS	405	SD221SB	322
PX3210	75	PX4351S	53	RA7RS	405	SD223SB	322
PX3211	75	PX4352S	54	RA8RS	405	SD224SB	323
PX3212S	206	PX4353S	49	RA9RS	405	SD225SB	323
PX3214S	72	PX4355	55	RAPLETTE	419	SD226SB	323
PX3215	78	PX4356	53	RC1	408	SD227SB	324
PX3216	78	PX4357	46	RC2	408	SD228SB	324
PX3217	78	PX4358	46	RC3	408	SD229SB	324
PX3218	80	PX4359	46	RC4	408	SD230SB	324
PX3219	80	PX4360S	52	RC5	408	SD231SB	322
PX3220	80	PX4361	51	REALGHIACCIA	364	SD232SB	322
PX3221	26, 81	PX4362	52	RG1	416	SD233SB	323
PX4301	63	PX4363	51	RG2	415	SD234SB	323
PX4302	63	PX4364	52	RM13	406	SD235SB	323

Code	Page	Code	Page	Code	Page	Code	Page
SD4COLSB	327	SP03250SB	347	T1007SB	316	TMOS2	402
SEM100	409	SP04250SB	347	T1008SB	316	TMQS	402
SEM1000	409	SP05250SB	347	T1009SB	316	TMQS2	402
SEM1500	409	SP07250SB	347	T1010SB	316	TMRS	402
SEM2000	409	SP08250SB	347	T1011SB	316	TMRS2	402
SEM300	409	SP1	413	T1012SB	316	TMTNS	402
SEM500	409	SP2	413	T1013SB	317	TMTNS2	402
SES100	409	SP3	413	T1014SB	317	TMTRS	402
SES1000	409	SP300FPC	392	T1015SB	317	TMTRS2	402
SES25	409	SP301FPC	392	T1016SB	317	TMTS	402
SES250	409	SP302FPC	392	T1017SB	317	TMTS2	402
SES50	409	SP303FPC	392	T1018SB	317	TMVS	402
SES500	409	SPV43	377	T1019SB	318	TMVS2	402
SET1000	409	SPV53	377	T1020SB	318	TOP01	153
SET150	409	SPV6242	377	T1021SB	318	TOP02	153
SET2000	409	SPV64	377	T1022SB	312	TOP03	154
SET250	409	SPV64MACARONS	377	T1023SB	312	TOP04	154
SET500	409	SPV86	377	T1024SB	312	TOP05	150
SET750	409	SPV88	377	T1025SB	313	TOP06	150
SETACCI0G05	412	SPVGASTRO 1/1	376	T1026SB	313	TOP07	150
SETACCI0G1	412	SRP	405	T1027SB	313	TOP08	151
SETACCI0P05	412	STP00	407	T1028SB	313	TOP09	151
SETACCI0P1	412	STP30D	407	T1029SB	313	TOP10	151
SF1M	412	STP31	407	T1030SB	313	TOP100	211
SFP	341	STP33	407	T1031SB	313	TOP101	211
SFP1	341	STP34	407	T1032SB	313	TOP102	211
SFP10	341	STP44	407	T1033SB	314	TOP103	211
SFP2	341	STP46	407	T1034SB	314	TOP104	211
SFP3	341	STP52B	407	T1035SB	314	TOP105	210
SFP4	341	STP52D	407	T1036SB	315	TOP106	210
SFP5	341	STP53B	407	T1037SB	312	TOP107	210
SFP6	341	STP540B	407	T1038SB	312	TOP11	151
SFP7	341	STP54B	407	T114SB	319	TOP12	153
SFP8	341	STP54L	407	T405SB	319	TOP13	152
SFP9	341	STP55L	407	TARTARUGA	404	TOP14	152
SH01	309	STP57	407	TCS	401	TOP15	152
SH02	309	STP58N	407	TCS2	401	TOP16	152
SM10SB	347	STP59	407	TES	401	TOP17	155
SM11SB	347	STP61B	407	TES2	401	TOP18	155
SM12SB	347	STP63	407	TFOOT-30SB	319	TOP19	155
SM13SB	347	STP64	407	TFOOT-70SB	319	TOP20	146
SMC144	386	STP65	407	TGS	401	TOP21	149
SMC72	386	STP67	407	TGS2	401	TOP22	148
SMD03*	366	STPROML	407	TH5986S	413	TOP23	147
SMD04A*	366	STRIP20FPC	379	TH5989	413	TOP24	146
SMD04B*	366	STRIP30FPC	379	TMCS	402	TOP25	149
SMD05*	366	STRIP35FPC	379	TMCS2	402	TOP26	148
SMD07A*	366	STRIP40FPC	379	TMD02*	366	TOP27	147
SMD07B*	366	STRKIT1	341	TMD04*	366	TOP28	18
SMD08*	366	STRKIT2	341	TMD05*	366	TOP29	19
SMD09*	366	T1000SB	315	TMD06*	366	TOP30	20
SMD10*	366	T1001SB	315	TMD08*	366	TOS	401
SMD100*	366	T1002SB	315	TMES	402	TOS2	401
SMD102*	366	T1003SB	315	TMES2	402	TP5	408
SMD11*	366	T1004SB	315	TMGS	402	TP6	408
SP01250SB	347	T1005SB	316	TMGS2	402	TP7	408
SP02250SB	347	T1006SB	316	TMOS	402	TPO1	408

Code	Page	Code	Page	Code	Page	Code	Page
TPO2	408	VP2T	382	X37	192	XF151535	182
TPO3	408	VP3BN	382	X3910	196	XF1520	180
TPO4	408	VP3NR	382	X3912	196	XF1535	180
TQS	401	VP3T	382	X3914	196	XF16	179
TQS2	401	VP4BN	383	X3916	196	XF17	181
TRAY	387	VP4NR	383	X3918	196	XF1720	180
TRAYGEL	207	VP5BN	383	X3920	196	XF1735	180
TRAYGELMINI	207	VP5NR	383	X3922	196	XF18	181
TRS	401	W200	415	X3924	196	XF19	181
TRS2	401	X01	192	X3926	196	XF191920	182
TTNS	401	X02	192	X3928	196	XF191935	182
TTNS2	401	X03	195	X3930	196	XF1920	180
TTRS	401	X04	195	X3932	196	XF1935	180
TTRS2	401	X05	195	X3934	196	XF197020	182
TTS	401	X06	195	X3936	196	XF197035	182
TTS2	401	X0602	196	X4010	196	XF20	181
TVS	401	X07	195	X4012	197	XF21	181
TVS2	401	X08	195	X4014	197	XF2120	180
TX01	142	X0802	196	X4016	197	XF2135	180
TX02	142	X1002	196	X4018	197	XF22	181
TX03	142	X1202	196	X4020	197	XF23	181
TX04	142	X121220	195	X4022	197	XF2320	180
VC1	385	X1402	196	X4024	197	XF2335	180
VC2	385	X1403	196	X4026	197	XF24	181
VC4	385	X141420	195	X4028	197	XF25	180
VC5	385	X1602	196	X4030	197	XF2520	180
VE1	414	X1603	196	X4032	197	XF26	180
VE1A	414	X161620	195	X4034	197	XF27	180
VE1G	414	X17	192	X4036	197	XF28	180
VE2	414	X18	192	X411836	197	XF29	180
VE2A	414	X1802	193	X413040	197	XF299020	180
VE2G	414	X1803	196	X414060	197	XF299035	180
VL120	372	X181820	195	X421836	197	XF30	180
VL140	372	X186020	195	X423040	197	XF31	180
VL160	372	X19	192	X424060	197	XF32	180
VL180	372	X20	192	X7718	197	XF4020	179
VL200	372	X2002	193, 196	X7720	197	XF5020	179
VL220	372	X21	192	X7722	197	XF51	184, 185
VL240	372	X22	192	X7724	197	XF52	184, 185
VL4030	373	X2202	193	X7726	197	XF53	184, 186
VL4035	373	X23	194	XF01	179	XF54	184, 186
VL6430	373	X24	194	XF02	179	XF55	184, 187
VL6435	373	X2402	196	XF03	182	XF56	184, 187
VL6440	373	X25	194	XF04	182	XF57	184, 188
VL65	372	X26	194	XF05	182	XF59	37, 184, 188
VLQ140	373	X2602	196	XF06	182		
VLQ160	373	X27	194	XF07	182		
VLQ180	373	X28	194	XF08	182		
VM1B	384	X2802	196	XF09	182		
VM2B	384	X288020	195	XF10	182		
VM3B	384	X29	194	XF11	179		
VM4B	384	X30	194	XF1120	179		
VP1BN	382	X31	193	XF12	179		
VP1NR	382	X32	193	XF13	179		
VP1T	382	X33	193	XF14	179		
VP2BN	382	X34	193	XF15	179		
VP2NR	382	X35	193	XF151520	182		

* fino a esaurimento /
until exhaustion

○ Novità / New products

Pavoni Italia

Code	Page	Code	Page
XF7020	179	ZP03SB	356
XF7035	179	ZP04SB	356
XF9020	179	ZP05SB	356
XF9035	179	ZP06SB	356
XFO197020	181	ZP07SB	356
XFO197035	181	ZUCCHERO INVERTITO	367
XFO299020	181		
XFO299035	181		
XFO656520	179		
XO186020	194		
XO288020	194		
YI06040C18SF	423		
YI06040P20SF	423		
YI06040P40DF	423		
YI08060C18SF	423		
ZP01SB	356		
ZP02SB	356		

Contenitori Crates

Code	Page	Code	Page	Code	Page
CARE/I	436	E6432	435	TB7527	444
CARE/P	436	E6435	435	TB7537	444
CARE/P	448	E6441	435	TB7569	446
CARE75/I	448	E6445	435	TB7569ADJR	447
CARTB6448-6463	448	E6470L	435	TB7569R6	446
CARTB7569	448	EF6407	435	TB7569R9	446
COPE43N C/G	437	EF6410	435		
COPE43N S/G	437	HP5332	449		
COPE64N	436	I10	439		
COPE64N C/G	436	I4	439		
COPE64	436	I6N	439		
COPI4	439	IC10	439		
COPI6N	439	IC4	439		
COPSL	438	IC6	439		
CP3226	449	IDL5	449		
CP5332	449	KITADJR	448		
E4312	437	KITR	448		
E4317	437	SL1	438		
E4322	437	SL2	438		
E4332	437	SL3	438		
E6407	434	SLX1	438		
E6409L	435	TB4326	443		
E6410	434	TB4332	443		
E6413	435	TB6426	443		
E6415	435	TB6432	443		
E6420	435	TB6432N	443		
E6426	435	TB6448	447		
E6429	435	TB6463	447		

Tutti gli articoli PAVONI ITALIA sono realizzati con materiali idonei al contatto di sostanze alimentari in conformità alle nuove disposizioni di legge. Le fotografie del presente catalogo non sono impegnative. I pesi e le misure possono essere soggetti a variazioni. / All PAVONI ITALIA items are made of materials suitable for food contact, in compliance with the new legal provisions. The pictures in this catalogue are not binding. Weights and measurements may be subject to variations.

CATFE24



Pavoni Italia S.p.A.
Via E. Fermi, s.n. - 24040 Suisio (BG) - Italia
T. +39 035 4934111 - F. +39 035 4948200
info@pavonitalia.com - www.pavonitalia.com

